



專業成就完美
Specialty Makes Perfect...



公司简介

Brief introduction

浙江伟鑫金属制品有限公司，是一家专业生产管道配件的实业公司。生产的铝合金、铜合金、不锈钢材料的凸轮锁紧快速接头，采用美国、德国标准制造。产品广泛用于军工、石油、化工等行业的输水、输油系统。

公司具有产品开发、模具制造，铝合金重力铸造、铜合金锻造、铝合金T6处理，产品生产加工等整套生产流程。产品远销欧、美、中东、澳洲、东南亚等国，深受客户信赖

公司本着“以人为本、质量第一、诚信至上、真诚合作”的原则，为您提供最优质的产品、最满意的服务。竭诚欢迎国内外朋友与我公司建立长期友好互惠的合作关系。

ZheJiang WAYSING Metal Products Co.,Ltd. specializes in the producing of hose coupling. We can provide the hose coupling in aluminum, brass and stainless steel. The product is produced strictly according with the F1122、A-A-59326 American standard or DIN2828 Germany standard,etc.

The company has the capability of self-development, mold design, gravity casting, forging and aluminum-alloy T6 heat treatment. We set up the whole process for product produce, quality control and so on. We have established friendly business relationship with clients throughout the world such as clients in Uk、USA、Australia. Etc.

We put all of our effort to produce the "world best hose coupling" with the highest quality and competitive price by means of continue development. With our strong technical background, we also can produce the product base on the clients' design and requirement. We sincerely welcome all friends from home and abroad for long-term cooperation.



ООО «ТИ-СИСТЕМС» ИНЖИНИРИНГ И ПОСТАВКА ТЕХНОЛОГИЧЕСКОГО ОБОРУДОВАНИЯ

Интернет: www.tisys.ru www.tisys.kz www.tisys.by www.tesec.ru www.ти-системс.рф

Телефоны: +7 (495) 7774788, 7489626, (925) 5007155, 54, 65 Эл. почта: info@tisys.ru info@tisys.kz info@tisys.by

STYLE(型号)	SIZE(尺寸)	PAPT#(料号)	Unit Price(价格)
TYPE A  MALE ADAPTER X FEMALE THREAD	1/2" (DN15)	A050-AL	
	3/4" (DN20)	A075-AL	
	1" (DN25)	A100-AL	
	1-1/4" (DN32)	A125-AL	
	1-1/2" (DN40)	A150-AL	
	2" (DN50)	A200-AL	
	2-1/2" (DN65)	A250-AL	
	3" (DN80)	A300-AL	
	4" (DN100)	A400-AL	
	5" (DN125)	A500-AL	
6" (DN150)	A600-AL		
8" (DN200)	A800-AL		

STYLE(型号)	SIZE(尺寸)	PAPT#(料号)	Unit Price(价格)
TYPE E  MALE ADAPTER X HOSE SHANK	1/2" (DN15)	E050-AL	
	3/4" (DN20)	E075-AL	
	1" (DN25)	E100-AL	
	1-1/4" (DN32)	E125-AL	
	1-1/2" (DN40)	E150-AL	
	2" (DN50)	E200-AL	
	2-1/2" (DN65)	E250-AL	
	3" (DN80)	E300-AL	
	4" (DN100)	E400-AL	
	5" (DN125)	E500-AL	
6" (DN150)	E600-AL		
8" (DN200)	E800-AL		

STYLE(型号)	SIZE(尺寸)	PAPT#(料号)	Unit Price(价格)
TYPE A  MALE ADAPTER X FEMALE THREAD	1/2" (DN15)	A050-BR	
	3/4" (DN20)	A075-BR	
	1" (DN25)	A100-BR	
	1-1/4" (DN32)	A125-BR	
	1-1/2" (DN40)	A150-BR	
	2" (DN50)	A200-BR	
	2-1/2" (DN65)	A250-BR	
	3" (DN80)	A300-BR	
	4" (DN100)	A400-BR	
	5" (DN125)	A500-BR	
6" (DN150)	A600-BR		

STYLE(型号)	SIZE(尺寸)	PAPT#(料号)	Unit Price(价格)
TYPE E  MALE ADAPTER X HOSE SHANK	1/2" (DN15)	E050-BR	
	3/4" (DN20)	E075-BR	
	1" (DN25)	E100-BR	
	1-1/4" (DN32)	E125-BR	
	1-1/2" (DN40)	E150-BR	
	2" (DN50)	E200-BR	
	2-1/2" (DN65)	E250-BR	
	3" (DN80)	E300-BR	
	4" (DN100)	E400-BR	
	5" (DN125)	E500-BR	
6" (DN150)	E600-BR		

STYLE(型号)	SIZE(尺寸)	PAPT#(料号)	Unit Price(价格)
TYPE B  FEMALE COUPLER X MALE THREAD	1/2" (DN15)	B050-AL	
	3/4" (DN20)	B075-AL	
	1" (DN25)	B100-AL	
	1-1/4" (DN32)	B125-AL	
	1-1/2" (DN40)	B150-AL	
	2" (DN50)	B200-AL	
	2-1/2" (DN65)	B250-AL	
	3" (DN80)	B300-AL	
	4" (DN100)	B400-AL	
	5" (DN125)	B500-AL	
6" (DN150)	B600-AL		
8" (DN200)	B800-AL		

STYLE(型号)	SIZE(尺寸)	PAPT#(料号)	Unit Price(价格)
TYPE F  MALE ADAPTER X MALE THREAD	1/2" (DN15)	F050-AL	
	3/4" (DN20)	F075-AL	
	1" (DN25)	F100-AL	
	1-1/4" (DN32)	F125-AL	
	1-1/4" (DN32)	F150-AL	
	2" (DN50)	F200-AL	
	2-1/2" (DN65)	F250-AL	
	3" (DN80)	F300-AL	
	4" (DN100)	F400-AL	
	5" (DN125)	F500-AL	
6" (DN150)	F600-AL		
8" (DN200)	F800-AL		

STYLE(型号)	SIZE(尺寸)	PAPT#(料号)	Unit Price(价格)
TYPE B  FEMALE COUPLER X MALE THREAD	1/2" (DN15)	B050-BR	
	3/4" (DN20)	B075-BR	
	1" (DN25)	B100-BR	
	1-1/4" (DN32)	B125-BR	
	1-1/2" (DN40)	B150-BR	
	2" (DN50)	B200-BR	
	2-1/2" (DN65)	B250-BR	
	3" (DN80)	B300-BR	
	4" (DN100)	B400-BR	
	5" (DN125)	B500-BR	
6" (DN150)	B600-BR		

STYLE(型号)	SIZE(尺寸)	PAPT#(料号)	Unit Price(价格)
TYPE F  MALE ADAPTER X MALE THREAD	1/2" (DN15)	F050-BR	
	3/4" (DN20)	F075-BR	
	1" (DN25)	F100-BR	
	1-1/4" (DN32)	F125-BR	
	1-1/2" (DN40)	F150-BR	
	2" (DN50)	F200-BR	
	2-1/2" (DN65)	F250-BR	
	3" (DN80)	F300-BR	
	4" (DN100)	F400-BR	
	5" (DN125)	F500-BR	
6" (DN150)	F600-BR		

STYLE(型号)	SIZE(尺寸)	PAPT#(料号)	Unit Price(价格)
TYPE C  FEMALE COUPLER X HOSE SHANK	1/2" (DN15)	C050-AL	
	3/4" (DN20)	C075-AL	
	1" (DN25)	C100-AL	
	1-1/4" (DN32)	C125-AL	
	1-1/2" (DN40)	C150-AL	
	2" (DN50)	C200-AL	
	2-1/2" (DN65)	C250-AL	
	3" (DN80)	C300-AL	
	4" (DN100)	C400-AL	
	5" (DN125)	C500-AL	
6" (DN150)	C600-AL		
8" (DN200)	C800-AL		

STYLE(型号)	SIZE(尺寸)	PAPT#(料号)	Unit Price(价格)
TYPE DC  DUST CAP	1/2" (DN15)	DC050-AL	
	3/4" (DN20)	DC075-AL	
	1" (DN25)	DC100-AL	
	1-1/4" (DN32)	DC125-AL	
	1-1/2" (DN40)	DC150-AL	
	2" (DN50)	DC200-AL	
	2-1/2" (DN65)	DC250-AL	
	3" (DN80)	DC300-AL	
	4" (DN100)	DC400-AL	
	5" (DN125)	DC500-AL	
6" (DN150)	DC600-AL		
8" (DN200)	DC800-AL		

STYLE(型号)	SIZE(尺寸)	PAPT#(料号)	Unit Price(价格)
TYPE C  FEMALE COUPLER X HOSE SHANK	1/2" (DN15)	C050-BR	
	3/4" (DN20)	C075-BR	
	1" (DN25)	C100-BR	
	1-1/4" (DN32)	C125-BR	
	1-1/2" (DN40)	C150-BR	
	2" (DN50)	C200-BR	
	2-1/2" (DN65)	C250-BR	
	3" (DN80)	C300-BR	
	4" (DN100)	C400-BR	
	5" (DN125)	C500-BR	
6" (DN150)	C600-BR		

STYLE(型号)	SIZE(尺寸)	PAPT#(料号)	Unit Price(价格)
TYPE DC  DUST CAP	1/2" (DN15)	DC050-BR	
	3/4" (DN20)	DC075-BR	
	1" (DN25)	DC100-BR	
	1-1/4" (DN32)	DC125-BR	
	1-1/2" (DN40)	DC150-BR	
	2" (DN50)	DC200-BR	
	2-1/2" (DN65)	DC250-BR	
	3" (DN80)	DC300-BR	
	4" (DN100)	DC400-BR	
	5" (DN125)	DC500-BR	
6" (DN150)	DC600-BR		

STYLE(型号)	SIZE(尺寸)	PAPT#(料号)	Unit Price(价格)
TYPE D  FEMALE COUPLER X FEMALE THREAD	1/2" (DN15)	D050-AL	
	3/4" (DN20)	D075-AL	
	1" (DN25)	D100-AL	
	1-1/4" (DN32)	D125-AL	
	1-1/2" (DN40)	D150-AL	
	2" (DN50)	D200-AL	
	2-1/2" (DN65)	D250-AL	
	3" (DN80)	D300-AL	
	4" (DN100)	D400-AL	
	5" (DN125)	D500-AL	
6" (DN150)	D600-AL		
8" (DN200)	D800-AL		

STYLE(型号)	SIZE(尺寸)	PAPT#(料号)	Unit Price(价格)
TYPE DP  DUST PLUG	1/2" (DN15)	DP050-AL	
	3/4" (DN20)	DP075-AL	
	1" (DN25)	DP100-AL	
	1-1/4" (DN32)	DP125-AL	
	1-1/2" (DN40)	DP150-AL	
	2" (DN50)	DP200-AL	
	2-1/2" (DN65)	DP250-AL	
	3" (DN80)	DP300-AL	
	4" (DN100)	DP400-AL	
	5" (DN125)	DP500-AL	
6" (DN150)	DP600-AL		
8" (DN200)	DP800-AL		

STYLE(型号)	SIZE(尺寸)	PAPT#(料号)	Unit Price(价格)
TYPE D  FEMALE COUPLER X FEMALE THREAD	1/2" (DN15)	D050-BR	
	3/4" (DN20)	D075-BR	
	1" (DN25)	D100-BR	
	1-1/4" (DN32)	D125-BR	
	1-1/2" (DN40)	D150-BR	
	2" (DN50)	D200-BR	
	2-1/2" (DN65)	D250-BR	
	3" (DN80)	D300-BR	
	4" (DN100)	D400-BR	
	5" (DN125)	D500-BR	
6" (DN150)	D600-BR		

STYLE(型号)	SIZE(尺寸)	PAPT#(料号)	Unit Price(价格)
TYPE DP  DUST PLUG	1/2" (DN15)	DP050-BR	
	3/4" (DN20)	DP075-BR	
	1" (DN25)	DP100-BR	
	1-1/4" (DN32)	DP125-BR	
	1-1/2" (DN40)	DP150-BR	
	2" (DN50)	DP200-BR	
	2-1/2" (DN65)	DP250-BR	
	3" (DN80)	DP300-BR	
	4" (DN100)	DP400-BR	
	5" (DN125)	DP500-BR	
6" (DN150)	DP600-BR		

STYLE (型号)
TYPE A



**MALE ADAPTER
X
FEMALE THREAD**

SIZE (尺寸)	PAPT#(料号)	Unit Price (价格)
1/2" (DN15)	A050-304	
3/4" (DN20)	A075-304	
1" (DN25)	A100-304	
1-1/4" (DN32)	A125-304	
1-1/2" (DN40)	A150-304	
2" (DN50)	A200-304	
2-1/2" (DN65)	A250-304	
3" (DN80)	A300-304	
4" (DN100)	A400-304	
5" (DN125)	A500-304	
6" (DN150)	A600-304	

STYLE (型号)
TYPE E



**MALE ADAPTER
X
HOSE SHANK**

SIZE (尺寸)	PAPT#(料号)	Unit Price (价格)
1/2" (DN15)	E050-304	
3/4" (DN20)	E075-304	
1" (DN25)	E100-304	
1-1/4" (DN32)	E125-304	
1-1/2" (DN40)	E150-304	
2" (DN50)	E200-304	
2-1/2" (DN65)	E250-304	
3" (DN80)	E300-304	
4" (DN100)	E400-304	
5" (DN125)	E500-304	
6" (DN150)	E600-304	

STYLE (型号)
TYPE A



**MALE ADAPTER
X
FEMALE THREAD**

SIZE (尺寸)	PAPT#(料号)	Unit Price (价格)
1/2" (DN15)	A050-316	
3/4" (DN20)	A075-316	
1" (DN25)	A100-316	
1-1/4" (DN32)	A125-316	
1-1/2" (DN40)	A150-316	
2" (DN50)	A200-316	
2-1/2" (DN65)	A250-316	
3" (DN80)	A300-316	
4" (DN100)	A400-316	
5" (DN125)	A500-316	
6" (DN150)	A600-316	

STYLE (型号)
TYPE E



**MALE ADAPTER
X
HOSE SHANK**

SIZE (尺寸)	PAPT#(料号)	Unit Price (价格)
1/2" (DN15)	E050-316	
3/4" (DN20)	E075-316	
1" (DN25)	E100-316	
1-1/4" (DN32)	E125-316	
1-1/2" (DN40)	E150-316	
2" (DN50)	E200-316	
2-1/2" (DN65)	E250-316	
3" (DN80)	E300-316	
4" (DN100)	E400-316	
5" (DN125)	E500-316	
6" (DN150)	E600-316	

STYLE (型号)
TYPE B



**FEMALE COUPLER
X
MALE THREAD**

SIZE (尺寸)	PAPT#(料号)	Unit Price (价格)
1/2" (DN15)	B050-304	
3/4" (DN20)	B075-304	
1" (DN25)	B100-304	
1-1/4" (DN32)	B125-304	
1-1/2" (DN40)	B150-304	
2" (DN50)	B200-304	
2-1/2" (DN65)	B250-304	
3" (DN80)	B300-304	
4" (DN100)	B400-304	
5" (DN125)	B500-304	
6" (DN150)	B600-304	

STYLE (型号)
TYPE F



**MALE ADAPTER
X
MALE THREAD**

SIZE (尺寸)	PAPT#(料号)	Unit Price (价格)
1/2" (DN15)	F050-304	
3/4" (DN20)	F075-304	
1" (DN25)	F100-304	
1-1/4" (DN32)	F125-304	
1-1/2" (DN40)	F150-304	
2" (DN50)	F200-304	
2-1/2" (DN65)	F250-304	
3" (DN80)	F300-304	
4" (DN100)	F400-304	
5" (DN125)	F500-304	
6" (DN150)	F600-304	

STYLE (型号)
TYPE B



**FEMALE COUPLER
X
MALE THREAD**

SIZE (尺寸)	PAPT#(料号)	Unit Price (价格)
1/2" (DN15)	B050-316	
3/4" (DN20)	B075-316	
1" (DN25)	B100-316	
1-1/4" (DN32)	B125-316	
1-1/2" (DN40)	B150-316	
2" (DN50)	B200-316	
2-1/2" (DN65)	B250-316	
3" (DN80)	B300-316	
4" (DN100)	B400-316	
5" (DN125)	B500-316	
6" (DN150)	B600-316	

STYLE (型号)
TYPE F



**MALE ADAPTER
X
MALE THREAD**

SIZE (尺寸)	PAPT#(料号)	Unit Price (价格)
1/2" (DN15)	F050-316	
3/4" (DN20)	F075-316	
1" (DN25)	F100-316	
1-1/4" (DN32)	F125-316	
1-1/2" (DN40)	F150-316	
2" (DN50)	F200-316	
2-1/2" (DN65)	F250-316	
3" (DN80)	F300-316	
4" (DN100)	F400-316	
5" (DN125)	F500-316	
6" (DN150)	F600-316	

STYLE (型号)
TYPE C



**FEMALE COUPLER
X
HOSE SHANK**

SIZE (尺寸)	PAPT#(料号)	Unit Price (价格)
1/2" (DN15)	C050-304	
3/4" (DN20)	C075-304	
1" (DN25)	C100-304	
1-1/4" (DN32)	C125-304	
1-1/2" (DN40)	C150-304	
2" (DN50)	C200-304	
2-1/2" (DN65)	C250-304	
3" (DN80)	C300-304	
4" (DN100)	C400-304	
5" (DN125)	C500-304	
6" (DN150)	C600-304	

STYLE (型号)
TYPE DC



DUST CAP

SIZE (尺寸)	PAPT#(料号)	Unit Price (价格)
1/2" (DN15)	DC050-304	
3/4" (DN20)	DC075-304	
1" (DN25)	DC100-304	
1-1/4" (DN32)	DC125-304	
1-1/2" (DN40)	DC150-304	
2" (DN50)	DC200-304	
2-1/2" (DN65)	DC250-304	
3" (DN80)	DC300-304	
4" (DN100)	DC400-304	
5" (DN125)	DC500-304	
6" (DN150)	DC600-304	

STYLE (型号)
TYPE C



**FEMALE COUPLER
X
HOSE SHANK**

SIZE (尺寸)	PAPT#(料号)	Unit Price (价格)
1/2" (DN15)	C050-316	
3/4" (DN20)	C075-316	
1" (DN25)	C100-316	
1-1/4" (DN32)	C125-316	
1-1/2" (DN40)	C150-316	
2" (DN50)	C200-316	
2-1/2" (DN65)	C250-316	
3" (DN80)	C300-316	
4" (DN100)	C400-316	
5" (DN125)	C500-316	
6" (DN150)	C600-316	

STYLE (型号)
TYPE DC



DUST CAP

SIZE (尺寸)	PAPT#(料号)	Unit Price (价格)
1/2" (DN15)	DC050-316	
3/4" (DN20)	DC075-316	
1" (DN25)	DC100-316	
1-1/4" (DN32)	DC125-316	
1-1/2" (DN40)	DC150-316	
2" (DN50)	DC200-316	
2-1/2" (DN65)	DC250-316	
3" (DN80)	DC300-316	
4" (DN100)	DC400-316	
5" (DN125)	DC500-316	
6" (DN150)	DC600-316	

STYLE (型号)
TYPE D



**FEMALE COUPLER
X
FEMALE THREAD**

SIZE (尺寸)	PAPT#(料号)	Unit Price (价格)
1/2" (DN15)	D050-304	
3/4" (DN20)	D075-304	
1" (DN25)	D100-304	
1-1/4" (DN32)	D125-304	
1-1/2" (DN40)	D150-304	
2" (DN50)	D200-304	
2-1/2" (DN65)	D250-304	
3" (DN80)	D300-304	
4" (DN100)	D400-304	
5" (DN125)	D500-304	
6" (DN150)	D600-304	

STYLE (型号)
TYPE DP



DUST PLUG

SIZE (尺寸)	PAPT#(料号)	Unit Price (价格)
1/2" (DN15)	DP050-304	
3/4" (DN20)	DP075-304	
1" (DN25)	DP100-304	
1-1/4" (DN32)	DP125-304	
1-1/2" (DN40)	DP150-304	
2" (DN50)	DP200-304	
2-1/2" (DN65)	DP250-304	
3" (DN80)	DP300-304	
4" (DN100)	DP400-304	
5" (DN125)	DP500-304	
6" (DN150)	DP600-304	

STYLE (型号)
TYPE D



**FEMALE COUPLER
X
FEMALE THREAD**

SIZE (尺寸)	PAPT#(料号)	Unit Price (价格)
1/2" (DN15)	D050-316	
3/4" (DN20)	D075-316	
1" (DN25)	D100-316	
1-1/4" (DN32)	D125-316	
1-1/2" (DN40)	D150-316	
2" (DN50)	D200-316	
2-1/2" (DN65)	D250-316	
3" (DN80)	D300-316	
4" (DN100)	D400-316	
5" (DN125)	D500-316	
6" (DN150)	D600-316	

STYLE (型号)
TYPE DP



DUST PLUG

SIZE (尺寸)	PAPT#(料号)	Unit Price (价格)
1/2" (DN15)	DP050-316	
3/4" (DN20)	DP075-316	
1" (DN25)	DP100-316	
1-1/4" (DN32)	DP125-316	
1-1/2" (DN40)	DP150-316	
2" (DN50)	DP200-316	
2-1/2" (DN65)	DP250-316	
3" (DN80)	DP300-316	
4" (DN100)	DP400-316	
5" (DN125)	DP500-316	
6" (DN150)	DP600-316	

STYLE (型号)	SIZE (尺寸)	PAPT#(料号)	Unit Price (价格)
TYPE A 	1/2"X3/4"	A050R-PP	
	3/4" (DN20)	A075-PP	
	1" (DN25)	A100-PP	
	1-1/4" (DN32)	A125-PP	
	1-1/2"X1-1/4"	A150R-PP	
	1-1/2" (DN40)	A150-PP	
	2" (DN50)	A200-PP	
	3" (DN80)	A300-PP	
4" (DN100)	A400-PP		

MALE ADAPTER
X
FEMALE THREAD

STYLE (型号)	SIZE (尺寸)	PAPT#(料号)	Unit Price (价格)
TYPE E 	1/2"X3/4"	E050R-PP	
	3/4" (DN20)	E075-PP	
	1" (DN25)	E100-PP	
	1-1/4" (DN32)	E125-PP	
	1-1/2"X1-1/4"	E150R-PP	
	1-1/2" (DN40)	E150-PP	
	2" (DN50)	E200-PP	
	3" (DN80)	E300-PP	
4" (DN100)	E400-PP		

MALE ADAPTER
X
HOSE SHANK

STYLE (型号)	SIZE (尺寸)	PAPT#(料号)	Unit Price (价格)
TYPE A 	1/2"X3/4"	A050R-NG	
	3/4" (DN20)	A075-NG	
	1" (DN25)	A100-NG	
	1-1/4" (DN32)	A125-NG	
	1-1/2"X1-1/4"	A150R-NG	
	1-1/2" (DN40)	A150-NG	
	2" (DN50)	A200-NG	
	3" (DN80)	A300-NG	
4" (DN100)	A400-NG		

MALE ADAPTER
X
FEMALE THREAD

STYLE (型号)	SIZE (尺寸)	PAPT#(料号)	Unit Price (价格)
TYPE E 	1/2"X3/4"	E050R-NG	
	3/4" (DN20)	E075-NG	
	1" (DN25)	E100-NG	
	1-1/4" (DN32)	E125-NG	
	1-1/2"X1-1/4"	E150R-NG	
	1-1/2" (DN40)	E150-NG	
	2" (DN50)	E200-NG	
	3" (DN80)	E300-NG	
4" (DN100)	E400-NG		

MALE ADAPTER
X
HOSE SHANK

STYLE (型号)	SIZE (尺寸)	PAPT#(料号)	Unit Price (价格)
TYPE B 	1/2"X3/4"	B050R-PP	
	3/4" (DN20)	B075-PP	
	1" (DN25)	B100-PP	
	1-1/4" (DN32)	B125-PP	
	1-1/2"X1-1/4"	B150R-PP	
	1-1/2" (DN40)	B150-PP	
	2" (DN50)	B200-PP	
	3" (DN80)	B300-PP	
4" (DN100)	B400-PP		

FEMALE COUPLER
X
MALE THREAD

STYLE (型号)	SIZE (尺寸)	PAPT#(料号)	Unit Price (价格)
TYPE F 	1/2"X3/4"	F050R-PP	
	3/4" (DN20)	F075-PP	
	1" (DN25)	F100-PP	
	1-1/4" (DN32)	F125-PP	
	1-1/2"X1-1/4"	F150R-PP	
	1-1/2" (DN40)	F150-PP	
	2" (DN50)	F200-PP	
	3" (DN80)	F300-PP	
4" (DN100)	F400-PP		

MALE ADAPTER
X
MALE THREAD

STYLE (型号)	SIZE (尺寸)	PAPT#(料号)	Unit Price (价格)
TYPE B 	1/2"X3/4"	B050R-NG	
	3/4" (DN20)	B075-NG	
	1" (DN25)	B100-NG	
	1-1/4" (DN32)	B125-NG	
	1-1/2"X1-1/4"	B150R-NG	
	1-1/2" (DN40)	B150-NG	
	2" (DN50)	B200-NG	
	3" (DN80)	B300-NG	
4" (DN100)	B400-NG		

FEMALE COUPLER
X
MALE THREAD

STYLE (型号)	SIZE (尺寸)	PAPT#(料号)	Unit Price (价格)
TYPE F 	1/2"X3/4"	F050R-NG	
	3/4" (DN20)	F075-NG	
	1" (DN25)	F100-NG	
	1-1/4" (DN32)	F125-NG	
	1-1/2"X1-1/4"	F150R-NG	
	1-1/2" (DN40)	F150-NG	
	2" (DN50)	F200-NG	
	3" (DN80)	F300-NG	
4" (DN100)	F400-NG		

MALE ADAPTER
X
MALE THREAD

STYLE (型号)	SIZE (尺寸)	PAPT#(料号)	Unit Price (价格)
TYPE C 	1/2"X3/4"	C050R-PP	
	3/4" (DN20)	C075-PP	
	1" (DN25)	C100-PP	
	1-1/4" (DN32)	C125-PP	
	1-1/2"X1-1/4"	C150R-PP	
	1-1/2" (DN40)	C150-PP	
	2" (DN50)	C200-PP	
	3" (DN80)	C300-PP	
4" (DN100)	C400-PP		

FEMALE COUPLER
X
HOSE SHANK

STYLE (型号)	SIZE (尺寸)	PAPT#(料号)	Unit Price (价格)
TYPE DC 	1/2"X3/4"	DC050R-PP	
	3/4" (DN20)	DC075-PP	
	1" (DN25)	DC100-PP	
	1-1/4" (DN32)	DC125-PP	
	1-1/2"X1-1/4"	DC150R-PP	
	1-1/2" (DN40)	DC150-PP	
	2" (DN50)	DC200-PP	
	3" (DN80)	DC300-PP	
4" (DN100)	DC400-PP		

DUST CAP

STYLE (型号)	SIZE (尺寸)	PAPT#(料号)	Unit Price (价格)
TYPE C 	1/2"X3/4"	C050R-NG	
	3/4" (DN20)	C075-NG	
	1" (DN25)	C100-NG	
	1-1/4" (DN32)	C125-NG	
	1-1/2"X1-1/4"	C150R-NG	
	1-1/2" (DN40)	C150-NG	
	2" (DN50)	C200-NG	
	3" (DN80)	C300-NG	
4" (DN100)	C400-NG		

FEMALE COUPLER
X
HOSE SHANK

STYLE (型号)	SIZE (尺寸)	PAPT#(料号)	Unit Price (价格)
TYPE DC 	1/2"X3/4"	DC050R-NG	
	3/4" (DN20)	DC075-NG	
	1" (DN25)	DC100-NG	
	1-1/4" (DN32)	DC125-NG	
	1-1/2"X1-1/4"	DC150R-NG	
	1-1/2" (DN40)	DC150-NG	
	2" (DN50)	DC200-NG	
	3" (DN80)	DC300-NG	
4" (DN100)	DC400-NG		

DUST CAP

STYLE (型号)	SIZE (尺寸)	PAPT#(料号)	Unit Price (价格)
TYPE D 	1/2"X3/4"	D050R-PP	
	3/4" (DN20)	D075-PP	
	1" (DN25)	D100-PP	
	1-1/4" (DN32)	D125-PP	
	1-1/2"X1-1/4"	D150R-PP	
	1-1/2" (DN40)	D150-PP	
	2" (DN50)	D200-PP	
	3" (DN80)	D300-PP	
4" (DN100)	D400-PP		

FEMALE COUPLER
X
FEMALE THREAD

STYLE (型号)	SIZE (尺寸)	PAPT#(料号)	Unit Price (价格)
TYPE DP 	1/2"X3/4"	DP050R-PP	
	3/4" (DN20)	DP075-PP	
	1" (DN25)	DP100-PP	
	1-1/4" (DN32)	DP125-PP	
	1-1/2"X1-1/4"	DP150R-PP	
	1-1/2" (DN40)	DP150-PP	
	2" (DN50)	DP200-PP	
	3" (DN80)	DP300-PP	
4" (DN100)	DP400-PP		

DUST PLUG

STYLE (型号)	SIZE (尺寸)	PAPT#(料号)	Unit Price (价格)
TYPE D 	1/2"X3/4"	D050R-NG	
	3/4" (DN20)	D075-NG	
	1" (DN25)	D100-NG	
	1-1/4" (DN32)	D125-NG	
	1-1/2"X1-1/4"	D150R-NG	
	1-1/2" (DN40)	D150-NG	
	2" (DN50)	D200-NG	
	3" (DN80)	D300-NG	
4" (DN100)	D400-NG		

FEMALE COUPLER
X
FEMALE THREAD

STYLE (型号)	SIZE (尺寸)	PAPT#(料号)	Unit Price (价格)
TYPE DP 	1/2"X3/4"	DP050R-NG	
	3/4" (DN20)	DP075-NG	
	1" (DN25)	DP100-NG	
	1-1/4" (DN32)	DP125-NG	
	1-1/2"X1-1/4"	DP150R-NG	
	1-1/2" (DN40)	DP150-NG	
	2" (DN50)	DP200-NG	
	3" (DN80)	DP300-NG	
4" (DN100)	DP400-NG		

DUST PLUG

STYLE (型号)	SIZE (尺寸)	PAPT#(料号)	Unit Price (价格)
TYPE A 	3/4"(DN20)	A75-BR-EN	
	1"(DN25)	A100-BR-EN	
	1-1/4"(DN32)	A125-BR-EN	
	1-1/2"(DN40)	A150-BR-EN	
	2"(DN50)	A200-BR-EN	
	2-1/2"(DN65)	A250-BR-EN	
	3"(DN80)	A300-BR-EN	
4"(DN100)	A400-BR-EN		

STYLE (型号)	SIZE (尺寸)	PAPT#(料号)	Unit Price (价格)
TYPE E 	3/4"(DN20)	E75-BR-EN	
	1"(DN25)	E100-BR-EN	
	1-1/4"(DN32)	E125-BR-EN	
	1-1/2"(DN40)	E150-BR-EN	
	2"(DN50)	E200-BR-EN	
	2-1/2"(DN65)	E250-BR-EN	
	3"(DN80)	E300-BR-EN	
4"(DN100)	E400-BR-EN		

SMOOTH HOSE TAIL WITH COLLAR

STYLE (型号)	SIZE (尺寸)	PAPT#(料号)	Unit Price (价格)
TYPE D 	3/4"(DN20)	D75-BR-EN	
	1"(DN25)	D100-BR-EN	
	1-1/4"(DN32)	D125-BR-EN	
	1-1/2"(DN40)	D150-BR-EN	
	2"(DN50)	D200-BR-EN	
	2-1/2"(DN65)	D250-BR-EN	
	3"(DN80)	D300-BR-EN	
4"(DN100)	D400-BR-EN		

STYLE (型号)	SIZE (尺寸)	PAPT#(料号)	Unit Price (价格)
TYPE E 	3/4"(DN20)	ES75-BR-EN	
	1"(DN25)	ES100-BR-EN	
	1-1/4"(DN32)	ES125-BR-EN	
	1-1/2"(DN40)	ES150-BR-EN	
	2"(DN50)	ES200-BR-EN	
	2-1/2"(DN65)	ES250-BR-EN	
	3"(DN80)	ES300-BR-EN	
4"(DN100)	ES400-BR-EN		

C MULTI-BARBS HOSE TAIL WITH COLLAR

STYLE (型号)	SIZE (尺寸)	PAPT#(料号)	Unit Price (价格)
TYPE C 	3/4"(DN20)	C75-BR-EN	
	1"(DN25)	C100-BR-EN	
	1-1/4"(DN32)	C125-BR-EN	
	1-1/2"(DN40)	C150-BR-EN	
	2"(DN50)	C200-BR-EN	
	2-1/2"(DN65)	C250-BR-EN	
	3"(DN80)	C300-BR-EN	
4"(DN100)	C400-BR-EN		

铝合金德标快速接头
ALUMINUM EN14420-7 CAMLOCK COUPLING

STYLE (型号)	SIZE (尺寸)	PAPT#(料号)	Unit Price (价格)
TYPE A 	3/4"(DN20)	A75-AL-EN	
	1"(DN25)	A100-AL-EN	
	1-1/4"(DN32)	A125-AL-EN	
	1-1/2"(DN40)	A150-AL-EN	
	2"(DN50)	A200-AL-EN	
	2-1/2"(DN65)	A250-AL-EN	
	3"(DN80)	A300-AL-EN	
4"(DN100)	A400-AL-EN		
5"(DN125)	A500-AL-EN		
6"(DN150)	A600-AL-EN		

BSPP THREAD WITH GASKET

STYLE (型号)	SIZE (尺寸)	PAPT#(料号)	Unit Price (价格)
TYPE C 	3/4"(DN20)	CS75-BR-EN	
	1"(DN25)	CS100-BR-EN	
	1-1/4"(DN32)	CS125-BR-EN	
	1-1/2"(DN40)	CS150-BR-EN	
	2"(DN50)	CS200-BR-EN	
	2-1/2"(DN65)	CS250-BR-EN	
	3"(DN80)	CS300-BR-EN	
4"(DN100)	CS400-BR-EN		

STYLE (型号)	SIZE (尺寸)	PAPT#(料号)	Unit Price (价格)
TYPE D 	3/4"(DN20)	D75-AL-EN	
	1"(DN25)	D100-AL-EN	
	1-1/4"(DN32)	D125-AL-EN	
	1-1/2"(DN40)	D150-AL-EN	
	2"(DN50)	D200-AL-EN	
	2-1/2"(DN65)	D250-AL-EN	
	3"(DN80)	D300-AL-EN	
4"(DN100)	D400-AL-EN		
5"(DN125)	D500-AL-EN		
6"(DN150)	D800-AL-EN		

BSPP THREAD WITH GASKET

STYLE (型号)	SIZE (尺寸)	PAPT#(料号)	Unit Price (价格)
TYPE A 	3/4"(DN20)	A75-SS-EN	
	1"(DN25)	A100-SS-EN	
	1-1/4"(DN32)	A125-SS-EN	
	1-1/2"(DN40)	A150-SS-EN	
	2"(DN50)	A200-SS-EN	
	2-1/2"(DN65)	A250-SS-EN	
	3"(DN80)	A300-SS-EN	
	4"(DN100)	A400-SS-EN	

STYLE (型号)	SIZE (尺寸)	PAPT#(料号)	Unit Price (价格)
	2"(DN50)	ES200-SS-EN	
	2-1/2"(DN65)	ES250-SS-EN	
	3"(DN80)	ES300-SS-EN	
	4"(DN100)	ES400-SS-EN	

TYPE E MULTI-BARBS HOSE TAIL WITH COLLAR

STYLE (型号)	SIZE (尺寸)	PAPT#(料号)	Unit Price (价格)
TYPE D 	3/4"(DN20)	D75-SS-EN	
	1"(DN25)	D100-SS-EN	
	1-1/4"(DN32)	D125-SS-EN	
	1-1/2"(DN40)	D150-SS-EN	
	2"(DN50)	D200-SS-EN	
	2-1/2"(DN65)	D250-SS-EN	
	3"(DN80)	D300-SS-EN	
	4"(DN100)	D400-SS-EN	

STYLE (型号)	SIZE (尺寸)	PAPT#(料号)	Unit Price (价格)
	3/4"(DN20)	E75-SS-EN	
	1"(DN25)	E100-SS-EN	
	1-1/4"(DN32)	E125-SS-EN	
	1-1/2"(DN40)	E150-SS-EN	
	2"(DN50)	E200-SS-EN	
	2-1/2"(DN65)	E250-SS-EN	
	3"(DN80)	E300-SS-EN	
	4"(DN100)	E400-SS-EN	

TYPE E SMOOTH HOSE TAIL WITH COLLAR

STYLE (型号)	SIZE (尺寸)	PAPT#(料号)	Unit Price (价格)
TYPE C 	2"(DN50)	CS200-SS-EN	
	2-1/2"(DN65)	CS250-SS-EN	
	3"(DN80)	CS300-SS-EN	
	4"(DN100)	CS400-SS-EN	

MULTI-BARBS HOSE TAIL WITH COLLAR

STYLE (型号)	SIZE (尺寸)	PAPT#(料号)	Unit Price (价格)

STYLE (型号)	SIZE (尺寸)	PAPT#(料号)	Unit Price (价格)
TYPE C 	3/4"(DN20)	C75-SS-EN	
	1"(DN25)	C100-SS-EN	
	1-1/4"(DN32)	C125-SS-EN	
	1-1/2"(DN40)	C150-SS-EN	
	2"(DN50)	C200-SS-EN	
	2-1/2"(DN65)	C250-SS-EN	
	3"(DN80)	C300-SS-EN	
	4"(DN100)	C400-SS-EN	

SMOOTH HOSE TAIL WITH COLLAR

STYLE (型号)	SIZE (尺寸)	PAPT#(料号)	Unit Price (价格)

STYLE(型号) **TYPE C1**



SIZE(尺寸) Unit Price(价格)

1-1/4" (DN32)
1-1/2" (DN40)
2" (DN50)
2-1/2" (DN65)
3" (DN80)
4" (DN100)

STYLE(型号) **TYPE E1**



SIZE(尺寸) Unit Price(价格)

1-1/4" (DN32)
1-1/2" (DN40)
2" (DN50)
2-1/2" (DN65)
3" (DN80)
4" (DN100)

STYLE(型号) **TYPE C2**



SIZE(尺寸) Unit Price(价格)

1-1/4" (DN32)
1-1/2" (DN40)
2" (DN50)
2-1/2" (DN65)
3" (DN80)
4" (DN100)

STYLE(型号) **TYPE E2**



SIZE(尺寸) Unit Price(价格)

1-1/4" (DN32)
1-1/2" (DN40)
2" (DN50)
2-1/2" (DN65)
3" (DN80)
4" (DN100)

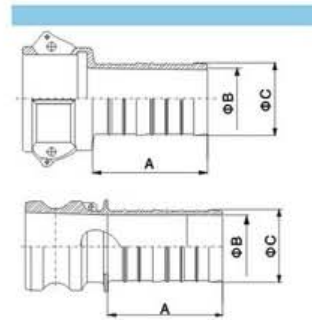

代号 型号	A	ΦB	2-ΦC
1-1/4"	64	25	33.4
1-1/2"	70	31.6	39.5
2"	82	43	52.3
2-1/2"	94	56	66
3"	105	68.9	78.5
4"	110	93	104

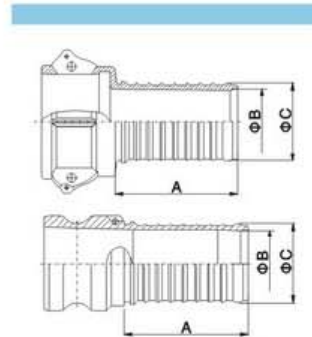

代号 型号	A	ΦB	ΦC
1-1/4"	64	25	33.4
1-1/2"	70	32	39.5
2"	82	43	52.3
2-1/2"	94	56	66
3"	105	68.9	78.5
4"	110	93	104

STYLE



可替换凸轮臂、环
REPLACEMENT HANDLES
INCLUDES RING & PIN

SIZE	Brass		SS304	
	PAPT#	Unit Price	PAPT#	Unit Price
1/2"-3/4"	BH075		SSH075	
1"	BH100		SSH100	
1-1/4"-2-1/2"	BH200		SSH200	
3"-5"	BH400		SSH400	
6"	BH600		SSH600	
8"	BH800		SSH800	
SIZE	ZINC			
	PAPT#	Unit Price		
1-1/4"-2-1/2"	ZC200			
3"-5"	ZC400			

STYLE(型号)



凸轮锁紧垫圈
CAM LOCK GASKETS BUNA-N

SIZE(尺寸)	PAPT#(料号)	Unit Price(价格)
1/2"	CLG050	
3/4"	CLG075	
1"	CLG100	
1-1/4"	CLG125	
1-1/2"	CLG150	
2"	CLG200	
2-1/2"	CLG250	
3"	CLG300	
4"	CLG400	
5"	CLG500	
6"	CLG600	
8"	CLG800	

STYLE



安全插销
SAFETY PIN

SIZE	STAINLESS STEEL		STELL	
	PAPT#	Unit Price	PAPT#	Unit Price
1/2"-1"	SPSS100		SPS100	
1-1/4"-8"	SPSS200		SPS200	

STYLE



销子
HANDLE PIN

SIZE	STAINLESS STEEL		STELL	
	PAPT#	Unit Price	PAPT#	Unit Price
1/2"	HPSS050		HPS050	
3/4"	HPSS075		HPS075	
1"	HPSS100		HPS100	
1-1/4"	HPSS125		HPS125	
1-1/2"	HPSS150		HPS150	
2"	HPSS200		HPS200	
2-1/2"	HPSS250		HPS250	
3"	HPSS300		HPS300	
4"	HPSS400		HPS400	
5"	HPSS500		HPS500	
6"	HPSS600		HPS600	
8"	HPSS800		HPS800	

STYLE (型号)	SIZE (尺寸)	PAPT#(料号)	Unit Price (价格)
TYPE CR			
	2" X 1-1/2"	CR2015AL	
	2-1/2" X 1-1/2"	CR2515AL	
	3" X 2"	CR3020AL	
	3" X 4"	CR3040AL	
	4" X 3"	CR4030AL	
	3" X 2-1/2"	CR3025-SS316	
FEMALE COUPLER X HOSE SHANK			

STYLE (型号)	SIZE (尺寸)	PAPT#(料号)	Unit Price (价格)
TYPE CVR			
	3"	CVR300AL	
	4"	CVR400AL	
	4" X 3"	CVR4030AL	
VAPOR RECOVERY COUPLER WITH PROBE			

STYLE (型号)	SIZE (尺寸)	PAPT#(料号)	Unit Price (价格)
TYPE BR			
	1-1/2" X 1"	BR1510AL	
	2" X 1-1/2"	BR2015AL	
	3" X 2"	BR3020AL	
	3" X 4"	BR3040AL	
	4" X 3"	BR4030AL	
FEMALE COUPLER X MALE THREAD			

STYLE (型号)	SIZE (尺寸)	PAPT#(料号)	Unit Price (价格)
TYPE DA			
	1-1/2" X 1"	DA1510AL	
	1-1/2" X 2"	DA1520AL	
	2" X 1-1/2"	DA2015AL	
	2" X 3"	DA2030AL	
	2" X 4"	DA2040AL	
	3" X 1-1/2"	DA3015AL	
	3" X 2"	DA3020AL	
	3" X 4"	DA3040AL	
	4" X 1-1/2"	DA4015AL	
	4" X 2"	DA4020AL	
	4" X 3"	DA4030AL	
	4" X 6"	DA4060AL	
	6" X 4"	DA6040AL	
	3" X 2"	DA3020BR	
	3" X 4"	DA3040BR	
	4" X 3"	DA4030BR	
	3" X 2"	DA3020-SS316	
FEMALE COUPLER X MALE ADAPTER			

STYLE (型号)	SIZE (尺寸)	PAPT#(料号)	Unit Price (价格)
TYPE DR			
	1-1/2" X 1"	DR1510AL	
	2" X 1-1/2"	DR2015AL	
	3" X 2"	DR3020AL	
	4" X 3"	DR4030AL	
FEMALE COUPLER X FEMALE THREAD			

STYLE (型号)	SIZE (尺寸)	PAPT#(料号)	Unit Price (价格)
TYPE DVR			
	3"	DVR300AL	
	4"	DVR400AL	
	4" X 3"	DVR4030AL	
VAPOR RECOVERY COUPLER WITH PROBE			

STYLE (型号)	SIZE (尺寸)	PAPT#(料号)	Unit Price (价格)
TYPE DD			
	1-1/2"	DD150AL	
	2"	DD200AL	
	3"	DD300AL	
	3" X 2"	DD3020AL	
	3" X 4"	DD3040AL	
	4"	DD400AL	
4"	DD400BR		
DOUBLE FEMALE COUPLER			

STYLE (型号)	SIZE (尺寸)	PAPT#(料号)	Unit Price (价格)
TYPE SA			
	1"	SA100AL	
	1-1/4"	SA125AL	
	1-1/2"	SA150AL	
	1-1/2" X 1"	SA1510AL	
	1-1/2" X 2"	SA1520AL	
	2"	SA200AL	
	2" X 3"	SA2030AL	
	3" X 4"	SA3040AL	
	3"	SA300AL	
	3" X 4"	SA3040AL	
	4"	SA400AL	
	4" X 2"	SA4020AL	
	4" X 6"	SA4060AL	
	6"	SA600AL	
	1"	SA100BR	
	1-1/2"	SA150BR	
	2"	SA200BR	
3"	SA300BR		
4"	SA400BR		
SPOOL ADAPTER			

STYLE (型号)	SIZE (尺寸)	PAPT#(料号)	Unit Price (价格)
TYPE AR			
	2" X 1-1/2"	AR2015AL	
	2" X 3"	AR2030AL	
	3" X 1-1/2"	AR3015AL	
	3" X 2"	AR3020AL	
	3" X 4"	AR3040AL	
	4" X 3"	AR4030AL	
	4" X 6"	AR4060AL	
6" X 4"	AR6040AL		

MALE ADAPTER X FEMALE THREAD

STYLE (型号)	SIZE (尺寸)	PAPT#(料号)	Unit Price (价格)
TYPE FA			
	2"	FA200AL	
	2-1/2"	FA250AL	
	3"	FA300AL	
	4"	FA400AL	
	6"	FA600AL	

MALE ADAPTER X FEMALE THREAD

STYLE (型号)	SIZE (尺寸)	PAPT#(料号)	Unit Price (价格)
TYPE ER			
	1-1/2" X 1"	ER1510AL	
	2" X 1-1/2"	ER2015AL	
	2" X 3"	ER2030AL	
	3" X 2"	ER3020AL	
	3" X 4"	ER3040AL	
	4" X 2"	ER4020AL	
	4" X 3"	ER4030AL	
	3" X 2-1/2"	ER3025-SS316	

MALE ADAPTER X HOSE SHANK

STYLE (型号)	SIZE (尺寸)	PAPT#(料号)	Unit Price (价格)
TYPE BF			
	3"	BF300AL	
	4"	BF400AL	

COUPLER X FLANGED

STYLE (型号)	SIZE (尺寸)	PAPT#(料号)	Unit Price (价格)
TYPE FR			
	1-1/2" X 3"	FR1530AL	
	2" X 1-1/2"	FR2015AL	
	2" X 3"	FR2030AL	
	2-1/2" X 1-1/2"	FR2515AL	
	3" X 1-1/2"	FR3015AL	
	3" X 2"	FR3020AL	
	3" X 4"	FR3040AL	
	4" X 3"	FR4030AL	
4" X 6"	FR4060AL		

MALE ADAPTER X MALE THREAD

STYLE (型号)	SIZE (尺寸)	PAPT#(料号)	Unit Price (价格)
TYPE FTF			
	3"	FTF300AL	
	4"	FTF400AL	

FEMALE THREAD X FLANGED

STYLE (型号)	SIZE (尺寸)	PAPT#(料号)	Unit Price (价格)
TYPE AF			
	2"	AF200AL	
	3"	AF300AL	
	4"	AF400AL	

ADAPTER X FLANGED

STYLE (型号)	SIZE (尺寸)	PAPT#(料号)	Unit Price (价格)
TYPE MTF			
	3"	MTF300AL	
	4"	MTF400AL	

MALE THREAD X FLANGED

STYLE (型号)	SIZE (尺寸)	PAPT#(料号)	Unit Price (价格)
 <p>3020&4030 6540</p> <p>THREAD REDUCER OR INCREASER</p>	3" M NPT X 2" F NPT-AL	3020AL	
	4" M NPT X 3" F NPT-AL	4030AL	
	6" M NPT X 5" F NPT X 4" M NPT-AL	6540AL	
	3" M NPT X 2" F NPT-BR	3020BR	
	4" M NPT X 3" F NPT-BR	4030BR	

STYLE (型号)	SIZE (尺寸)	PAPT#(料号)	Unit Price (价格)
 <p>COUPLER</p>	Bend 90 Degree 2" X 2"	Bend200	
	Bend 90 Degree 3" X 3"	Bend300	

STYLE (型号)	SIZE (尺寸)	PAPT#(料号)	Unit Price (价格)
<p>TYPE DCL</p>  <p>LOCKABLE DUST CAP</p>	2"	DCL200-AL	
	3"	DCL300-AL	
	4"	DCL400-AL	
	2"	DCL200-BR	
	3"	DCL300-BR	
	4"	DCL400-BR	

STYLE (型号)	SIZE (尺寸)	PAPT#(料号)	Unit Price (价格)
 <p>LUGGED TYPEA</p>	Adaptr 2.5" X 2.5" thread	A2525L-AL	
	Adaptr 3" X 3" thread	A3030L-AL	
	Adaptr 3" X 2.5" thread	A3025L-AL	
	Adaptr 3" X 2" thread	A3020L-AL	
	Adaptr 4" X 4" thread	A4040L-AL	
	Adaptr 4" X 3" thread	A4030L-AL	
	Adaptr 4" X 2.5" thread	A4025L-AL	
	Adaptr 4" X 2" thread	A4020L-AL	

STYLE (型号)	SIZE (尺寸)	PAPT#(料号)	Unit Price (价格)
 <p>DOUBLE MALE NIPPLE WITH LUG-ALUMINUM</p>	1-1/2" M X 1-1/4" F	150M125F	
	1-1/2" M X 1-1/2" F	150M150F	
	1-1/2" M X 2" F	150M200F	
	1-1/2" M X 2-1/2" F	150M250F	
	1-1/2" M X 3" F	150M300F	
	2" M X 1-1/4" F	200M125F	
	2" M X 1-1/2" F	200M150F	
	2" M X 2" F	200M200F	
	2" M X 2-1/2" F	200M250F	
	2" M X 3" F	200M300F	
	2-1/2" M X 2" F	250M200F	
	2-1/2" M X 2-1/2" F	250M250F	
	2-1/2" M X 3" F	250M300F	
	2-1/2" M X 4" F	250M400F	
	3" M X 2" F	300M200F	
	3" M X 2-1/2" F	300M250F	
3" M X 3" F	300M300F		
3" M X 4" F	300M400F		
4" M X 3" F	400M300F		
4" M X 4" F	400M400F		

STYLE (型号)	SIZE (尺寸)	PAPT#(料号)	Unit Price (价格)
 <p>MALE X FEMALE NIPPLE WITH LUG-ALUMINUM</p>	1-1/2" M X 1-1/2" M	150M150M	
	2" M X 1-1/2" M	200M150M	
	2" M X 2" M	200M200M	
	2-1/2" M X 2" M	250M200M	
	2-1/2" M X 2-1/2" M	250M250M	
	3" M X 2" M	300M200M	
	3" M X 2-1/2" M	300M250M	
	3" M X 3" M	300M300M	
	4" M X 3" M	400M300M	
	4" M X 4" M	400M400M	

STYLE (型号)	SIZE (尺寸)	PAPT#(料号)	Unit Price (价格)
 <p>单向阀接头 ALUMINUM VALVE WITH A BALL</p>	1-1/2"	150VB	
	2"	200VB	

STYLE (型号)	SIZE (尺寸)	PAPT#(料号)	Unit Price (价格)
 <p>ALUMINUM LUNG NUT</p>	1-1/2"	LN150-AL	
	2"	LN200-AL	
	2-1/2"	LN250-AL	
	3"	LN300-AL	
	4"	LN400-AL	

STYLE (型号)	SIZE (尺寸)	PAPT#(料号)	Unit Price (价格)
 <p>吸水管接头 ALUMINUM SUCTION HOSE COUPLING</p>	1-1/2"	SHC150-AL	
	2"	SHC200-AL	
	3"	SHC300-AL	
	4"	SHC400-AL	

STYLE (型号)	SIZE (尺寸)	PAPT#(料号)	Unit Price (价格)
 <p>ALUMINUM SERRATED TAIL END</p>	1-1/2"	STE150-AL	
	2"	STE200-AL	
	2-1/2"	STE250-AL	
	3"	STE300-AL	
	4"	STE400-AL	

STYLE (型号)	SIZE (尺寸)	PAPT#(料号)	Unit Price (价格)
 <p>混凝土接头A型 CONCRETE COUPLINGS TYPE A</p>	1-1/2"	AWSS-A 150	
	2"	AWSS-A 200	
	2-1/2"	AWSS-A 250	

STYLE (型号)	SIZE (尺寸)	PAPT#(料号)	Unit Price (价格)
 <p>PIN LUG CAP</p>	1-1/2"	PLC150-AL	
	2"	PLC200-AL	
	2-1/2"	PLC250-AL	
	3"	PLC300-AL	
	4"	PLC400-AL	

STYLE (型号)	SIZE (尺寸)	PAPT#(料号)	Unit Price (价格)
 <p>混凝土接头C型 CONCRETE COUPLINGS TYPE C</p>	1-1/2"	CWSHK-C 150	
	2"	CWSHK-C 200	
	2-1/2"	CWSHK-C 250	

STYLE (型号)	SIZE (尺寸)	PAPT#(料号)	Unit Price (价格)
 <p>ADAPTER STRAIGHT</p>	1-1/2"	BP150-AL	
	2"	BP200-AL	
	2-1/2"	BP250-AL	
	3"	BP300-AL	
	4"	BP400-AL	

STYLE (型号)	SIZE (尺寸)	PAPT#(料号)	Unit Price (价格)
 <p>混凝土接头D型 CONCRETE COUPLINGS TYPE D</p>	1-1/2"	DWSHK-D 150	
	2"	DWSHK-D 200	
	2-1/2"	DWSHK-D 250	

STYLE(型号)	SIZE(尺寸)	PAPT#(料号)	Unit Price(价格)
 <p>标准凸耳管接头 STANDARD PIN LUG COUPLINGS</p>	1-1/2" NPSM	PL-150	
	2" NPSM	PL-200	
	2-1/2" NPSM	PL-250	
	3" NPSM	PL-300	
	4" NPSM	PL-400	
	6" NPSM	PL-600	

STYLE(型号)	SIZE(尺寸)	PAPT#(料号)	Unit Price(价格)
 <p>双螺旋转管接头 COMPOSITE COUPLINGS</p>	2"	CHC200-AL	
	2-1/2"	CHC250-AL	
	3"	CHC300-AL	
	4"	CHC400-AL	

STYLE(型号)	SIZE(尺寸)	PAPT#(料号)	Unit Price(价格)
 <p>68度弯双螺旋转管接头 68° BENDING COMPOSITE COUPLINGS</p>	3"	CHCB300-AL	
	4"	CHCB400-AL	

STYLE(型号)	SIZE(尺寸)	PAPT#(料号)	Unit Price(价格)
 <p>管尾旋转接头 SWILVE CAMLOCK COUPLING</p>	2"	SC-200-AL	
	2-1/2"	SC-250-AL	
	3"	SC-300-AL	
	4"	SC-400-AL	
	6"	SC-600-AL	

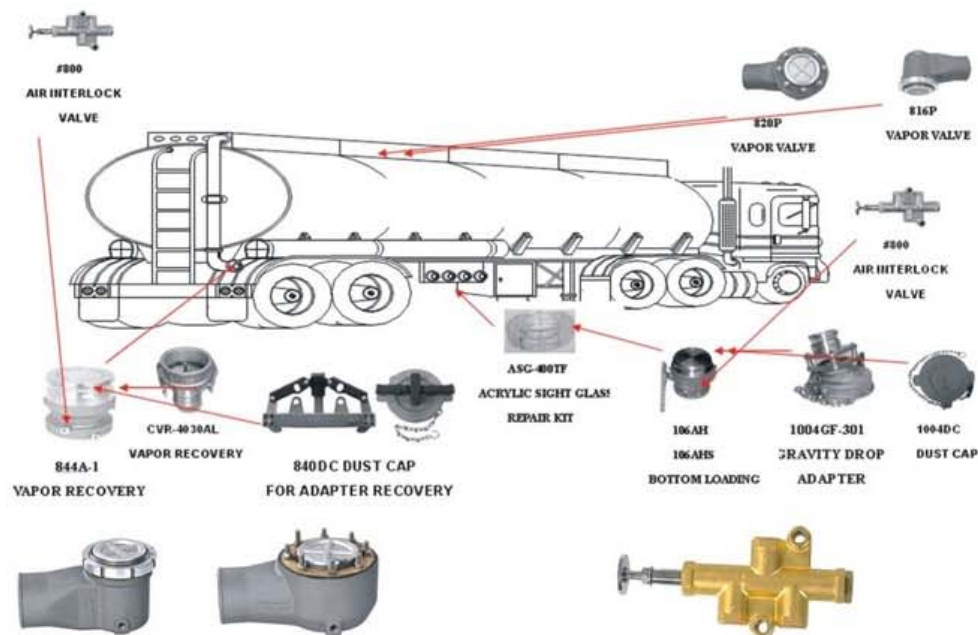

Pneumatic Vapor Valve for 16" and 20" Man Hole Cover		
Size	Part No.	Price
3"	816P	
3"	820P	

Feature of 3" Vapor Valve:
 Poppet Opens into Tank to prevent leakage from surges or from overturned tank 7.354 square inches of flow are
 Hard Anodized aluminum hood and low profile
 Tapered seat design with Viton O-Ring Seal Provides Leak-tight seal
 Stainless steel spring screws bolts and nuts resist corrosion
 1/4" NPT external pneumatic connection
 820P installs easily off-set in 20" manhole or separate 3" TTMA size mount ring



Fuel Tanker Product A.P.14 Openable Adapter Bottom loading & Unloading 106

Features Benefits
 Heat Treated Aluminum Construction With Brass Ring
 Stainless steel Poppet for longer life
 Multi-Position short stroke aluminum handle with smooth rotation of less than 60 degree
 Meets with API RP1004 Specifications with a standard 4" TTMA Flange
 Sight Glass for detecting liquids
 Viton Seals are standard for compatibility with high octane fuels and additives
 Hydrodynamic design to minimize pressure drop for high flow rates

Pneumatic Air Interlock Valve A.P.I		

Features Benefits
 Brass Forged body with all stainless steel components
 Unique design with filter adjustable contact pad and shaft accommodates 1/4" NPT installs Pneumatic connection
 Can be installed as normally closed or open valve
 Can be installed atop side or bottom side
 To connect API's bottom loading adapter or Vapor Recovery adapter



1004DC DUST CAP

Features of API Dust Cap
 Aluminum alloy construction with self-locking device
 Meet with API RP 1004 Specifications
 Nylon-Glass cam handle with self-locking feature reduce wear and non-corrosive
 Cam handle and Lug designed for one hand operation

STYLE (型号)	Size	Part No.	Description
	4"x3"	1004GA-300	4"Coupler x3" Adaptor
	4"x4"	1004GA-400	4"Coupler x4" Adaptor
	4"x3"	1004GA-300M	4"Coupler x3" Male NPT
	4"x4"	1004GA-400M	4"Coupler x4" Male NPT
	4"x3"	1004GA-300MB	4"Coupler x3" Male BSP
	4"x4"	1004GA-400MB	4"Coupler x4" Male BSP
	4"x3"	1004GA-300S	4"Coupler x3" Adaptor With sight Glass
	4"x4"	1004GA-400S	4"Coupler x4" Adaptor With sight Glass
	4"x3"	1004GA-300V	4"Coupler x3" Adaptor With Valve
	4"x4"	1004GA-400V	4"Coupler x4" Adaptor With Valve

API GRAVITY DROP ADAPTER

Gravity Drop Adapter
Feature of Gravity Drop Adaptor and Coupler:
Attach directly against openable API
Allow drop hose with standard camlock coupling to clamp on and transfer petroleum from API Valve
Meet API RP 1004 Specifications
Heat treatment aluminum alloy

STYLE (型号)	SIZE	PAPT#	Unit Price (价格)
	3"	DVR300AL	
	4"	DVR400AL	
	4" X 3"	DVR4030AL	

VAPOR RECOVERY COUPLER WITH PROBE

STYLE (型号)	SIZE	PAPT#	Unit Price (价格)
	3"	CVR300AL	
	4"	CVR400AL	
	4" X 3"	CVR4030AL	

VAPOR RECOVERY COUPLER WITH PROBE

STYLE (型号)	SIZE	PART NO.	Unit Price (价格)
	4"	840DC	

LOCKABLE 4" DUST CAP FOR VAPOR RECOVERY

Features:
Orange for color coding
Nylon Glass lockable pull out handle with stainless steel arms can be locked from either side of handle
Ability to add safety chains to cap from either side
one hand operation to open or close

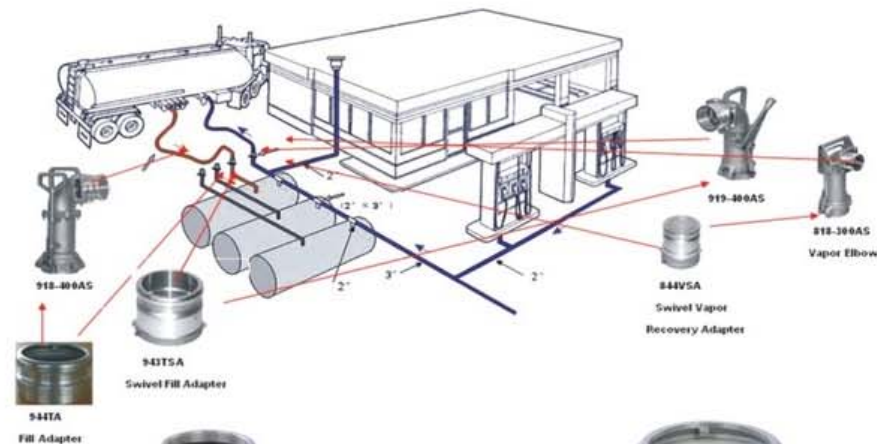

Adapter with poppet x Female NPT

SIZE	PAPT#	Price
4"x3"	843A	
4"x4"	844A	

Fill Adapter Top Seal Dual Point

SIZE	Part No.	Price
4"x3"	943TA	
4"x4"	944TA	

Product Vapor Elbow - Dual point

Part No.	Description	Price
818-300A	Outlet AF300	
818-400A	Outlet AF400	
818-300CP	Outlet AF300CP	
818-300B	Outlet BF300	
818-400B	Outlet BF400	

Feature:
Heavy duty aluminum alloy construction. Center of Gravity at handle easy to operate. 360 degree round rigid glass window on top. 5 degree angled four bolt flange pattern with variety of different inlets to meet any requirement.

Swivel Fill Adapter Top Seal Dual Point

SIZE	Part No.	Price
4"x3"	943TSA	
4"x4"	944TSA	

WX Dry-Disconnect Coupling

STYLE (型号)



Adapter X Female NPT			
Size	Aluminum/BUNA	StainlessSteel/Teflon	
1-1/2"	621A-150	673A-150	
2"	621A-200	673A-200	
3"	621A-300	673A-300	

Coupler X Female NPT			
Size	Aluminum/BUNA	StainlessSteel/Teflon	
1-1/2"	761D-150	773D-150	
2"	761D-200	773D-200	
3"	761D-300	773D-300	

Repair Kits			
Size	Adaptor/BUNA	Coupler/Teflon	
1-1/2"	RK 150AB	RK 150DV	
2"	RK 200AB	RK 200DV	
3"	RK 300AB	RK 300DV	



Size Considerations			
Line Size	Dry-Disconnect Adapter or Coupler	Cam & Groove Adapter or Coupler	
1-1/2"	1-1/2"	2"	
2"	2"	2-1/2"	
3"	3"	4"	

Not to be used as a shut off valve.
Coupler with self-locking handles
Working pressure: 1-1/2" and 2" at 150 psi
3" at 125 psi

REPAIR PARTS FOR 919 & 918 PRODUCT ELBOWS

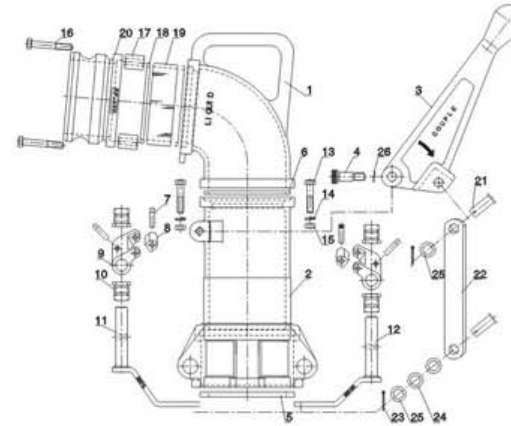

Feature:

Heavy duty aluminium alloy construction
One piece aluminium alloy construction
easy to operate 5 degree angled four bolt
flange pattern with variety of different
inlets to meet any requirement

零件20(919B-AF-400AL)是进(出)油接头,为选
配件,根据客户使用要求更换。可替换的零件为:
AF-300AL, AF-400AL, BF-300AL, BF-400AL, MTF-300AL, MTF-400AL.



Product Elbow - Dual Point		
Part No.	Description	Price
919-300AS	Inlet AF300 W sight Glass	
919-400AS	Inlet AF400 W sight Glass	
919-300BS	Inlet BF300 W sight Glass	
919-400BS	Inlet BF400 W sight Glass	
919-300MS	Inlet MTF300 W sight Glass	
919-400MS	Inlet MTF400 W sight Glass	
919-300FS	Inlet FTF300 W sight Glass	
919-400FS	Inlet FTF400 W sight Glass	
919-300A	Inlet AF300 W/O sight Glass	
919-400A	Inlet AF400 W/O sight Glass	

26	919B-71202	波形弹性垫圈	Waved Washer	1	碳钢
25	919B-71203	平垫圈	Flat Washer	3	SS304
24	919B-71204	锥形弹性垫圈	Waved Washer	1	SS304
23	919B-72520	开口销	Cotter Pin	2	SS304
22	919B-791911	联接臂	Flat Linkage	1	SS304
21	919B-71232	销轴	Clevis Pin	2	SS304
20	919B-AF-400AL	进(出)油接头	Inlet Adapter-3A	1	ZL101A
19	919B-900SG	玻璃视镜	Sight Glass	1	有机玻璃
18	919B-903G	垫圈(观察窗)	Gasket	2	丁腈耐油橡胶
17	919B-21925	支撑柱	Space Holder	4	6061
16	919B-77954	六角螺栓(公头)	Bolt	4	SS304
15	919B-77906	六角螺母	Hex Nut	4	SS304
14	919B-77902	弹簧垫圈	Spring Washer	4	SS304
13	919B-77938	六角螺栓(母头)	Bolt	4	SS304
12	919B-92212	右联接臂	Right Linkage Arm	1	SS304
11	919B-92211	左联接臂	Left Linkage Arm	1	SS304
10	919B-31620	套筒	Sleeve	4	HPb59-1
9	919B-79009	凸轮臂	Cam Arm	2	SS304
8	919B-79008	凸轮	Cam	2	SS304
7	919B-76325	带滚花圆柱销	Pin	4	SS304
6	919B-902G	中间垫圈	Gasket Connect	1	丁腈耐油橡胶
5	919B-901G	母头垫圈	Gasket Fill Adapter	1	丁腈耐油橡胶
4	919B-11210	内六角圆柱头轴肩螺钉	Shoulder screw	1	碳钢
3	919B-29193	扳手	Handle	1	ZL101A
2	919B-29019	下本体	Lower Body	1	ZL101A
1	919B-29090	上本体	Upper Body	1	ZL101A

STYLE (型号)	SIZE (尺寸)	管径	PAPT#(料号)	Unit Price (价格)
	2" (DN50)	Φ53	GHL-200M-AL	
	2-1/2" (DN65)	Φ67.5	GHL-250M-AL	
	3" (DN80)	Φ82.5	GHL-300M-AL	
	4" (DN100)	Φ106	GHL-400M-AL	

螺旋管尾
GUILLEMIN COUPLING WITH LOCK RING AND MULTI-SERRATED HOSE TAIL

STYLE (型号)	SIZE (尺寸)	管径	PAPT#(料号)	Unit Price (价格)
	3/4" (DN20)	Φ25	GHL-75L-AL	
	1" (DN25)	Φ30	GHL-100L-AL	
	1-1/4" (DN32)	Φ35	GHL-125L-AL	
	1-1/2" (DN40)	Φ40.5	GHL-150L-AL	
	2" (DN50)	Φ55	GHL-200L-AL	
	2-1/2" (DN65)	Φ70	GHL-250L-AL	
	3" (DN80)	Φ90	GHL-300L-AL	
	4" (DN100)	Φ110	GHL-400L-AL	

短管尾
GUILLEMIN COUPLING WITH LOCK RING AND MULTI-SERRATED SHORE HOSE TAIL

STYLE (型号)	SIZE (尺寸)	管径	PAPT#(料号)	Unit Price (价格)
	1-1/2" (DN40)	Φ45	GHL-150S-AL	
	2" (DN50)	Φ51	GHL-200S-AL	
	2-1/2" (DN65)	Φ63	GHL-250S-AL	
	3" (DN80)	Φ78	GHL-300S-AL	
	4" (DN100)	Φ102	GHL-400S-AL	

长管尾
GUILLEMIN COUPLING WITH LOCK RING AND MULTI-SERRATED LONG HOSE TAIL

STYLE (型号)	SIZE (尺寸)	PAPT#(料号)	Unit Price (价格)
	3/4" (DN20)	GM-75-AL	
	1" (DN25)	GM-100-AL	
	1-1/4" (DN32)	GM-125-AL	
	1-1/2" (DN40)	GM-150-AL	
	2" (DN50)	GM-200-AL	
	2-1/2" (DN65)	GM-250-AL	
	3" (DN80)	GM-300-AL	
	4" (DN100)	GM-400-AL	

不带锁外螺纹接头
GUILLEMIN COUPLING WITHOUT LOCK RING AND MALE BSP PARALLEL THREAD

STYLE (型号)	SIZE (尺寸)	PAPT#(料号)	Unit Price (价格)
	3/4" (DN20)	GF-75-AL	
	1" (DN25)	GF-100-AL	
	1-1/4" (DN32)	GF-125-AL	
	1-1/2" (DN40)	GF-150-AL	
	2" (DN50)	GF-200-AL	
	2-1/2" (DN65)	GF-250-AL	
	3" (DN80)	GF-300-AL	
	4" (DN100)	GF-400-AL	

不带锁内螺纹接头
GUILLEMIN COUPLING WITH FEALE BSP PARALLEL THREAD WITHOUT LOCK RING

STYLE (型号)	SIZE (尺寸)	PAPT#(料号)	Unit Price (价格)
	3/4" (DN20)	GML-75-AL	
	1" (DN25)	GML-100-AL	
	1-1/4" (DN32)	GML-125-AL	
	1-1/2" (DN40)	GML-150-AL	
	2" (DN50)	GML-200-AL	
	2-1/2" (DN65)	GML-250-AL	
	3" (DN80)	GML-300-AL	
	4" (DN100)	GML-400-AL	

带锁外螺纹接头
GUILLEMIN COUPLING WITH LOCK RING AND MALE BSP PARALLEL THREAD

STYLE (型号)	SIZE (尺寸)	PAPT#(料号)	Unit Price (价格)
	3/4" (DN20)	GFL-75-AL	
	1" (DN25)	GFL-100-AL	
	1-1/4" (DN32)	GFL-125-AL	
	1-1/2" (DN40)	GFL-150-AL	
	2" (DN50)	GFL-200-AL	
	2-1/2" (DN65)	GFL-250-AL	
	3" (DN80)	GFL-300-AL	
	4" (DN100)	GFL-400-AL	

带锁内螺纹接头
HALF COUPLING WITH LOCKING RING AND FEMALE BSP THREAD

STYLE (型号)	SIZE (尺寸)	PAPT#(料号)	Unit Price (价格)
	3/4" (DN20)	GBC-75-AL	
	1" (DN25)	GBC-100-AL	
	1-1/4" (DN32)	GBC-125-AL	
	1-1/2" (DN40)	GBC-150-AL	
	2" (DN50)	GBC-200-AL	
	2-1/2" (DN65)	GBC-250-AL	
	3" (DN80)	GBC-300-AL	
	4" (DN100)	GBC-400-AL	

防尘盖
GUILLEMIN COUPLING BLANK CAP WITH LOCK RING AND C/W CHAIN

STYLE (型号)	SIZE (尺寸)	PAPT#(料号)	Unit Price (价格)
	1-1/2" (DN40)	GHP-150-AL	
	2" (DN50)	GHP-200-AL	
	3" (DN80)	GHP-300-AL	

手提式法式防尘盖
HANDLE PLUG WITHOUT LOCKING RING, WITH CHAIN

STYLE (型号)	SIZE (尺寸)	PAPT#(料号)	Unit Price (价格)
	3/4" (DN20)	GL-75-AL	
	1" (DN25)	GL-100-AL	
	1-1/4" (DN32)	GL-125-AL	
	1-1/2" (DN40)	GL-150-AL	
	2" (DN50)	GL-200-AL	
	2-1/2" (DN65)	GL-250-AL	
	3" (DN80)	GL-300-AL	
	4" (DN100)	GL-400-AL	

锁环
GUILLEMIN COUPLING LOCK RING

STYLE (型号)	SIZE (尺寸)	PAPT#(料号)	Unit Price (价格)
	3/4" (DN20)	GCG-75-AL	
	1" (DN25)	GCG-100-AL	
	1-1/4" (DN32)	GCG-125-AL	
	1-1/2" (DN40)	GCG-150-AL	
	2" (DN50)	GCG-200-AL	
	2-1/2" (DN65)	GCG-250-AL	
	3" (DN80)	GCG-300-AL	
	4" (DN100)	GCG-400-AL	

橡胶垫
GASKET

STYLE (型号)	SIZE (尺寸)	PAPT#(料号)	Unit Price (价格)
	1-1/4" X 1" DN32 X DN25	GC-1210-AL	
	1-1/2" X 1" DN40 X DN25	GC-1510-AL	
	1-1/2" X 1-1/4" DN40 X DN32	GC-1512-AL	
	2" X 1" DN50 X DN25	GC-2010-AL	
	2" X 1-1/4" DN50 X DN32	GC-2012-AL	
	2" X 1-1/2" DN50 X DN40	GC-2015-AL	
	2-1/2" X 1-1/2" DN65 X DN40	GC-2515-AL	
	2-1/2" X 2" DN65 X DN50	GC-2520-AL	
	3" X 1-1/2" DN80 X DN40	GC-3015-AL	
	3" X 2" DN80 X DN50	GC-3020-AL	
	3" X 2-1/2" DN80 X DN65	GC-3025-AL	
	4" X 1-1/2" DN100 X DN40	GC-4015-AL	
	4" X 2" DN100 X DN50	GC-4020-AL	
	4" X 2-1/2" DN100 X DN65	GC-4025-AL	
4" X 3" DN100 X DN80	GC-4030-AL		
6" X 4" DN150 X DN100	GC-6040-AL		

异径法式接头
REDUCING TYPE OF GUILLEMIN COUPLING

STYLE (型号)	SIZE (尺寸)	管径	PAPT#(料号)	Unit Price (价格)
	2" (DN50)	Φ53	GHL-200M-SS	
	2-1/2" (DN65)	Φ67.5	GHL-250M-SS	
	3" (DN80)	Φ82.5	GHL-300M-SS	
	4" (DN100)	Φ106	GHL-400M-SS	

螺旋管尾
GUILLEMIN COUPLING WITH LOCK RING AND MULTI-SERRATED HOSE TAIL

STYLE (型号)	SIZE (尺寸)	管径	PAPT#(料号)	Unit Price (价格)
	1/2" (DN15)	Φ19.5	GHL-50L-SS	
	3/4" (DN20)	Φ25	GHL-75L-SS	
	1" (DN25)	Φ30	GHL-100L-SS	
	1-1/4" (DN32)	Φ35	GHL-125L-SS	
	1-1/2" (DN40)	Φ40.5	GHL-150L-SS	
	2" (DN50)	Φ55	GHL-200L-SS	
	2-1/2" (DN65)	Φ70	GHL-250L-SS	
	3" (DN80)	Φ90	GHL-300L-SS	
4" (DN100)	Φ110	GHL-400L-SS		

短管尾
GUILLEMIN COUPLING WITH LOCK RING AND MULTI-SERRATED SHORE HOSE TAIL

STYLE (型号)	SIZE (尺寸)	管径	PAPT#(料号)	Unit Price (价格)
	1-1/2" (DN40)	Φ45	GHL-150S-SS	
	2" (DN50)	Φ51	GHL-200S-SS	
	2-1/2" (DN65)	Φ63	GHL-250S-SS	
	3" (DN80)	Φ76	GHL-300S-SS	
	4" (DN100)	Φ102	GHL-400S-SS	

长管尾
GUILLEMIN COUPLING WITH LOCK RING AND MULTI-SERRATED LONG HOSE TAIL

STYLE (型号)	SIZE (尺寸)	PAPT#(料号)	Unit Price (价格)
	1/2" (DN15)	GM-50-SS	
	3/4" (DN20)	GM-75-SS	
	1" (DN25)	GM-100-SS	
	1-1/4" (DN32)	GM-125-SS	
	1-1/2" (DN40)	GM-150-SS	
	2" (DN50)	GM-200-SS	
	2-1/2" (DN65)	GM-250-SS	
	3" (DN80)	GM-300-SS	
4" (DN100)	GM-400-SS		

不带锁外螺纹接头
GUILLEMIN COUPLING WITHOUT LOCK RING AND MALE BSP PARALLEL THREAD

STYLE (型号)	SIZE (尺寸)	PAPT#(料号)	Unit Price (价格)
 <p>不带锁内螺纹接头 GUILLEMIN COUPLING WITH FEALE BSP PARALLEL THREAD WITHOUT LOCK RING</p>	1/2"(DN15)	GF-50-SS	
	3/4"(DN20)	GF-75-SS	
	1"(DN25)	GF-100-SS	
	1-1/4"(DN32)	GF-125-SS	
	1-1/2"(DN40)	GF-150-SS	
	2"(DN50)	GF-200-SS	
	2-1/2"(DN65)	GF-250-SS	
	3"(DN80)	GF-300-SS	
4"(DN100)	GF-400-SS		

STYLE (型号)	SIZE (尺寸)	PAPT#(料号)	Unit Price (价格)
 <p>1/2"-1-1/4" 1-1/2"-4" 防尘盖 GUILLEMIN COUPLING BLANK CAP WITH LOCK RING AND C/W CHAIN</p>	1/2"(DN15)	GBC-50-SS	
	3/4"(DN20)	GBC-75-SS	
	1"(DN25)	GBC-100-SS	
	1-1/4"(DN32)	GBC-125-SS	
	1-1/2"(DN40)	GBC-150-SS	
	2"(DN50)	GBC-200-SS	
	2-1/2"(DN65)	GBC-250-SS	
	3"(DN80)	GBC-300-SS	
4"(DN100)	GBC-400-SS		

STYLE (型号)	SIZE (尺寸)	PAPT#(料号)	Unit Price (价格)
 <p>带锁外螺纹接头 GUILLEMIN COUPLING WITH LOCK RING AND MALE BSP PARALLEL THREAD</p>	1/2"(DN15)	GML-50-SS	
	3/4"(DN20)	GML-75-SS	
	1"(DN25)	GML-100-SS	
	1-1/4"(DN32)	GML-125-SS	
	1-1/2"(DN40)	GML-150-SS	
	2"(DN50)	GML-200-SS	
	2-1/2"(DN65)	GML-250-SS	
	3"(DN80)	GML-300-SS	
4"(DN100)	GML-400-SS		

STYLE (型号)	SIZE (尺寸)	PAPT#(料号)	Unit Price (价格)
 <p>锁环 GUILLEMIN COUPLING LOCK RING</p>	1/2"(DN15)	GL-50-SS	
	3/4"(DN20)	GL-75-SS	
	1"(DN25)	GL-100-SS	
	1-1/4"(DN32)	GL-125-SS	
	1-1/2"(DN40)	GL-150-SS	
	2"(DN50)	GL-200-SS	
	2-1/2"(DN65)	GL-250-SS	
	3"(DN80)	GL-300-SS	
4"(DN100)	GL-400-SS		

STYLE (型号)	SIZE (尺寸)	PAPT#(料号)	Unit Price (价格)
 <p>带锁内螺纹接头 HALF COUPLING WITH LOCKING RING AND FEMALE BSP THREAD</p>	1/2"(DN15)	GFL-50-SS	
	3/4"(DN20)	GFL-75-SS	
	1"(DN25)	GFL-100-SS	
	1-1/4"(DN32)	GFL-125-SS	
	1-1/2"(DN40)	GFL-150-SS	
	2"(DN50)	GFL-200-SS	
	2-1/2"(DN65)	GFL-250-SS	
	3"(DN80)	GFL-300-SS	
4"(DN100)	GFL-400-SS		

STYLE (型号)	SIZE (尺寸)	PAPT#(料号)	Unit Price (价格)
 <p>光滑管尾 SMOOTH TAIL</p>	1-1/2"(DN40)	GHLS-150-SS	
	2"(DN50)	GHLS-200-SS	
	2-1/2"(DN65)	GHLS-250-SS	
	3"(DN80)	GHLS-300-SS	
	4"(DN100)	GHLS-400-SS	

STYLE (型号)	SIZE (尺寸)	PAPT#(料号)	Unit Price (价格)
 <p>承插 FEMALE FOR WELDING</p>	1/2"(DN15)	GW-50-SS	
	3/4"(DN20)	GW-75-SS	
	1"(DN25)	GW-100-SS	
	1-1/4"(DN32)	GW-125-SS	
	1-1/2"(DN40)	GW-150-SS	
	2"(DN50)	GW-200-SS	
	2-1/2"(DN65)	GW-250-SS	
	3"(DN80)	GW-300-SS	
4"(DN100)	GW-400-SS		

STYLE (型号)	SIZE (尺寸)	PAPT#(料号)	Unit Price (价格)
 <p>HOSE REEL</p>			

STYLE (型号)	SIZE (尺寸)	管径	PAPT# (料号)	Unit Price (价格)
	3/4"(DN20)	Φ25	GHL-75S-BR	
	1"(DN25)	Φ30	GHL-100S-BR	
	1-1/4"(DN32)	Φ35	GHL-125S-BR	
	1-1/2"(DN40)	Φ40.5	GHL-150S-BR	
	1-1/2"(DN40)	Φ45	GHL-150L-BR	
	2"(DN50)	Φ55	GHL-200S-BR	

短管尾
GUILLEMIN COUPLING WITH LOCK RING AND MULTI-SERRATED SHORE HOSE TAIL

STYLE (型号)	SIZE (尺寸)	PAPT# (料号)	Unit Price (价格)
	3/4"(DN20)	GML-75-BR	
	1"(DN25)	GML-100-BR	
	1-1/4"(DN32)	GML-125-BR	
	1-1/2"(DN40)	GML-150-BR	
	2"(DN50)	GML-200-BR	

带锁外螺纹接头
GUILLEMIN COUPLING WITH LOCK RING AND MALE BSP PARALLEL THREAD

STYLE (型号)	SIZE (尺寸)	PAPT# (料号)	Unit Price (价格)
	3/4"(DN20)	GM-75-BR	
	1"(DN25)	GM-100-BR	
	1-1/4"(DN32)	GM-125-BR	
	1-1/2"(DN40)	GM-150-BR	
	2"(DN50)	GM-200-BR	

不带锁外螺纹接头
GUILLEMIN COUPLING WITHOUT LOCK RING AND MALE BSP PARALLEL THREAD

STYLE (型号)	SIZE (尺寸)	PAPT# (料号)	Unit Price (价格)
	3/4"(DN20)	GFW-75-BR	
	1"(DN25)	GFW-100-BR	
	1-1/4"(DN32)	GFW-125-BR	
	1-1/2"(DN40)	GFW-150-BR	
	2"(DN50)	GFW-200-BR	

承插
FEMALE FOR WELDING

STYLE (型号)	SIZE (尺寸)	PAPT# (料号)	Unit Price (价格)
	3/4"(DN20)	GL-75-BR	
	1"(DN25)	GL-100-BR	
	1-1/4"(DN32)	GL-125-BR	
	1-1/2"(DN40)	GL-150-BR	
	2"(DN50)	GL-200-BR	

锁环
GUILLEMIN COUPLING LOCK RING



1号扳手
Key1



2号扳手
Key2

STYLE (型号)	SIZE (尺寸)	PAPT# (料号)	Unit Price (价格)
	1-1/2" M NST x 1-1/2" M NST	14-146 20	
	1-1/2" M NPT x 1-1/2" M NPS	14-146 22	
	1-1/2" M NST x 1-1/2" M NPT	14-146 25	
	1-1/2" M NPT x 1-1/2" M NPSH	14-146 30	
	2-1/2" M NPT x 1-1/2" M NST	14-146 35	
	2-1/2" M NST x 1-1/2" M NPT	14-146 40	
	2-1/2" M NST x 1-1/2" M NST	14-146 50	
	2-1/2" M NST x 2" M NST	14-146 55	
	2-1/2" M NPSH x 2" M NST	14-146 60	
	2-1/2" M NST x 2" M NPT	14-146 65	
	2-1/2" M BAT x 2" M NPT	14-146 67	
	2-1/2" M NST x 2-1/2" M NPT	14-146 73	
	2-1/2" M BAT x 2-1/2" M BAT	14-146 73-1	
	2-1/2" M NPT x 2-1/2" M BAT	14-146 73-2	
	2-1/2" M NPT x 2-1/2" NPS	14-146 73-3	
	2-1/2" M NST x 2-1/2" M NST	14-146 75	
	3" M NPT x 2-1/2" M NST	14-146 82	
	3" M NPT x 2-1/2" M BAT	14-146 83	
	4" M NST x 4" M NPT	14-146 90	
	4-1/2" M NST x 4" M NPT	14-146 92	

六角双外螺纹接头
BRASS HEX NIPPLE DOUBLE MALE
100PSI WORKING PRESSURE MAX

STYLE (型号)	SIZE (尺寸)	PAPT# (料号)	Unit Price (价格)
	1-1/2" F NST x 1-1/2" F NST	14-156 20	
	1-1/2" F NST x 1-1/2" F NPT	14-156 25	
	2-1/2" F NPT x 2-1/2" F NST	14-156 60	
	2-1/2" F NST x 2-1/2" F NST	14-156 65	

六角双内螺纹接头
BRASS HEX NIPPLE FEMALE X FEMALE

STYLE (型号)	SIZE (尺寸)	PAPT# (料号)	Unit Price (价格)
	3/4" F GHT x 1" M NPT	14-155 18	
	1" F NPT x 3/4" M GHT	14-155 20	
	1-1/2" F NST x 1" M NPT	14-155 23	
	1-1/2" F NPT x 1" M NPT	14-155 24	
	1-1/2" F NPT x 1-1/2" M NST	14-155 25	
	1-1/2" F NPSH x 1-1/2" M NPSH	14-155 30	
	1-1/2" F NST x 1-1/2" M NPT	14-155 35	
	2-1/2" F NPT x 1-1/2" M NST	14-155 40	
	2-1/2" F NST x 1-1/2" M NST	14-155 45	
	2-1/2" F NST x 2" M NPT	14-155 48	
	2-1/2" F NPSH x 2-1/2" M NPT	14-155 50	
	2-1/2" F NST x 2-1/2" M NST	14-155 55	
	2-1/2" F NST x 2-1/2" M NPT	14-155 60	
	2-1/2" F NPT x 2-1/2" M NST	14-155 70	
	3" F NPT x 2-1/2" M NST	14-155 71	
	2-1/2" F NPSH x 2-1/2" M NST	14-155 80	
	4" F NST x 2-1/2" M NST	14-155 90	
	4-1/2" F NST x 2-1/2" M NST	14-155 93	

六角内外螺纹接头
BRASS HEX NIPPLE FEMALE X MALE
100PSI WORKING PRESSURE MAX

STYLE (型号)	SIZE (尺寸)	PAPT#(料号)	Unit Price(价格)
 <p>补芯 BRASS HEX FEMALE X MALE ADAPTER</p>	1-1/2" F NST x 2" M NST	15-216 32	
	1-1/2" F NST x 2-1/2" M NST	15-216 40	
	1-1/2" F NPT x 2-1/2" M NST	15-216 42	
	2" F NPT x 2-1/2" M NST	15-216 50	
	2-1/2" F NST x 3" M NPT	15-216 77	
	4" F NPT x 4-1/2" M NST	15-216 80	

STYLE (型号)	SIZE (尺寸)	PAPT#(料号)	Unit Price(价格)
 <p>外螺纹防尘盖 PLUG & CHAIN</p>	1-1/2" M NST (Plug)	17-127 15	
	1-1/2" M NPS (Plug)	17-127 20	
	2-1/2" M BAT (Plug)	17-127 22	
	2-1/2" M NST (Plug)	17-127 25	
	3" M NST (Plug)	17-127 30	

STYLE (型号)	SIZE (尺寸)	PAPT#(料号)	Unit Price(价格)
 <p>活接头: 内螺纹x外螺纹 MALE SOLID X FEM SWIV W/GASKET-SINGLE SWIV</p>	1-1/2" F NST x 1-1/2" M NPT	09-215 20	
	1-1/2" F NPS x 1-1/2" M NPT	09-215 30	
	1-1/2" F NPSH x 1-1/2" M NPT	09-215 47	
	2-1/2" F NST x 2" M NPT	09-215 50	
	2-1/2" F BAT x 2" M NPT	09-215 55	
	2-1/2" F NST x 2-1/2" M NPT	09-215 70	
	2-1/2" F BAT x 2-1/2" M NPT	09-215 73	
	2-1/2" F NST x 3" M NPT	09-215 80	

STYLE (型号)	SIZE (尺寸)	PAPT#(料号)	Unit Price(价格)
 <p>黄铜缩径接头 FORGING BRASS FIRE REDUCER</p>	1-1/2" F NST x 3/4" M GHT	09-130 09	
	1-1/2" F NPS x 3/4" M GHT	09-130 10	
	1-1/2" F NST x 1" M NPT	09-130 11	
	1-1/2" F NPS x 1" M NPT	09-130 12	
	1-1/2" F NST x 1" M NPSH	09-130 13	
	2-1/2" F NST x 3/4" M NPT	09-130 36	
	2-1/2" F NST x 3/4" M GHT	09-130 37	
	2-1/2" F BAT x 3/4" M GHT	09-130 38	
	2-1/2" F NST x 1" M NPSH	09-130 39	
	2-1/2" F BAT x 1" M NPSH	09-130 40	
	2-1/2" F NPT x 1-1/2" M NST	09-130 45	
	2-1/2" F NPSH x 1-1/2" M NPT	09-130 50	
	2-1/2" F BAT x 1-1/2" M NPT	09-130 51	
	2-1/2" F NPSH x 1-1/2" M NST	09-130 53	
	2-1/2" F NST x 1-1/2" M NPT	09-130 55	
	2-1/2" F NST x 1-1/2" M NST	09-130 57	
	2-1/2" F NST x 2" M NPT	09-130 60	
	2-1/2" F NST x 2" M NPSH	09-130 62	
	2-1/2" F NST x 2" M NST	09-130 65	
	2-1/2" F NPSH x 2" M NPT	09-130 67	
2-1/2" F BAT x 2" M NPT	09-130 68		
2-1/2" F NPSH x 2" M NST	09-130 69		
2-1/2" F NST x 1-1/2" M NPSH	09-130 71		
3" F NPT x 2-1/2" M NST	09-130 75		
2-1/2" F NST x 1-1/2" M NPT	09-130 77		
2-1/2" F NST x 2" M NPT	09-130 78		

STYLE (型号)	SIZE (尺寸)	PAPT#(料号)	Unit Price(价格)
 <p>活接头: 内螺纹x内螺纹 BRASS DOUBLE FEMALE SWIVEL</p>	1-1/2" F NST x 1-1/2" F NST	09-115 20	
	1-1/2" F NPT x 1-1/2" F NST	09-115 25	
	1-1/2" F NPS x 1-1/2" F NPS	09-115 26	
	1-1/2" F NPSH x 1-1/2" F NST	09-115 30	
	1-1/2" F NPSH x 1-1/2" F NPSH	09-115 31	
	1-1/2" F NPT x 1-1/2" F NPSH	09-115 35	
	2-1/2" F NPT x 2-1/2" F NST	09-115 55	
	2-1/2" F NPT x 2-1/2" F BAT	09-115 56	
	2-1/2" F NST x 2-1/2" F NST	09-115 60	

STYLE (型号)	SIZE (尺寸)	PAPT#(料号)	Unit Price(价格)
 <p>BRASS DOUBLE MALE PIN LUG</p>	1-1/2" M NPSH x 1-1/2" M NPSH	09-114 21	
	2-1/2" M NPSH x 2-1/2" M NPT	09-114 50	
	2-1/2" M NPSH x 2-1/2" M NST	09-114 55	

STYLE (型号)	SIZE (尺寸)	PAPT#(料号)	Unit Price(价格)
 <p>防尘盖 CAP & CHAIN</p>	1-1/2" NST BRASS	17-126 30	
	1-1/2" NPS BRASS	17-126 32	
	1-1/2" NPSH BRASS	17-126 40	
	2-1/2" NST BRASS	17-126 50	
	2-1/2" NPSH BRASS	17-126 60	
	2-1/2" BAT BRASS	17-126 61	
	4" NST BRASS	17-126 62	
	4-1/2" NST BRASS	17-126 65	

STYLE (型号)	SIZE (尺寸)	PAPT#(料号)	Unit Price (价格)
	1-1/2" NH x 1-11/16"	ECRT-150 x 172NH	
	1-1/2" NPSH x 1-11/16"	ECRT-150 x 172NPSH	
	1-1/2" NH x 1-3/4"	ECRT-150 x 175NH	
	1-1/2" NPSH x 1-3/4"	ECRT-150 x 175NPSH	
	1-1/2" NH x 1-13/16"	ECRT-150 x 180NH	
	1-1/2" NPSH x 1-13/16"	ECRT-150 x 180NPSH	
	1-1/2" NH x 1-15/16"	ECRT-150 x 190NH	
	1-1/2" NPSH x 1-15/16"	ECRT-150 x 190NPSH	
	1-1/2" NH x 2-1/8"	ECRT-150 x 210NH	
	1-1/2" NPSH x 2-1/8"	ECRT-150 x 210NPSH	
	1-1/2" NH x 2-1/16"	ECRT-150 x 220NH	
	1-1/2" NPSH x 2-1/16"	ECRT-150 x 220NPSH	
	2" NH x 2-5/16"	ECRT-200 x 230NH	
	2" NPSH x 2-5/16"	ECRT-200 x 230NPSH	
	2-1/2" NH x 2-3/4"	ECRT-250 x 275NH	
	2-1/2" NPSH x 2-3/4"	ECRT-250 x 275NPSH	
	2-1/2" NH x 2-13/16"	ECRT-250 x 280NH	
	2-1/2" NPSH x 2-13/16"	ECRT-250 x 280NPSH	
	2-1/2" NH x 3"	ECRT-250 x 300NH	
	2-1/2" NPSH x 3"	ECRT-250 x 300NPSH	
	4" NH-4 x 4-9/16"	ECRT-400 x 450NH	
	4" NH-6 x 4-9/16"	ECRT-400 x 450NPSH	



EXPANSION COUPLING ROCKER TYPE

STYLE (型号)	SIZE (尺寸)	PAPT#(料号)	Unit Price (价格)
	1-1/2" NH x 1-11/16"	RCLT-150 x 172NH	
	1-1/2" NPSH x 1-11/16"	RCLT-150 x 172NPSH	
	1-1/2" NH x 1-3/4"	RCLT-150 x 175NH	
	1-1/2" NPSH x 1-3/4"	RCLT-150 x 175NPSH	
	1-1/2" NH x 1-13/16"	RCLT-150 x 180NH	
	1-1/2" NPSH x 1-13/16"	RCLT-150 x 180NPSH	
	1-1/2" NH x 1-15/16"	RCLT-150 x 190NH	
	1-1/2" NPSH x 1-15/16"	RCLT-150 x 190NPSH	
	1-1/2" NH x 2-1/16"	RCLT-150 x 220NH	
	1-1/2" NPSH x 2-1/16"	RCLT-150 x 220NPSH	
	2" NH x 2-5/16"	RCLT-200 x 230NH	
	2" NPSH x 2-5/16"	RCLT-200 x 230NPSH	
	2-1/2" NH x 2-3/4"	RCLT-250 x 275NH	
	2-1/2" NPSH x 2-3/4"	RCLT-250 x 275NPSH	
	2-1/2" NH x 2-13/16"	RCLT-250 x 280NH	
	2-1/2" NPSH x 2-13/16"	RCLT-250 x 280NPSH	
	2-1/2" NH x 3"	RCLT-250 x 300NH	
	2-1/2" NPSH x 3"	RCLT-250 x 300NPSH	



EXPANSION COUPLING PIN LUG TYPE

STYLE (型号)	SIZE (尺寸)	PAPT#(料号)	Unit Price (价格)
	1-1/2"	ECSR-150	
	2"	ECSR-200	
	2-1/2"	ECSR-250	

SLEEVE

STYLE (型号)	SIZE (尺寸)	PAPT#(料号)	Unit Price (价格)
	1-1/2"	ECC-150	
	2"	ECC-200	
	2-1/2"	ECC-250	

CLIP



SLEEVE



CLIP

STYLE (型号)	SIZE (尺寸)	D	L	KA	Unit Price (价格)
	D-25 DIN 14301	25	53	31	
	C-52 DIN 14332	42	55	66	
	C-52 DIN 14302	52	55	66	
	C-52 DIN 86202	52	75	66	
	C-52 DIN 14321	52	90	66	
	65	52	60	81	
	65	65	60	81	
	65	75	65	81	
	65	52	72	81	
	B-75 DIN 14303	75	60	89	
	B-75 DIN 86203	75	85	89	
	B-75 DIN 14322	75	125	89	
	A-110 DIN 14323	110	170	133	



STORZ COUPLING WITH HOSE SHANK

STYLE (型号)	SIZE (尺寸)	Thread	KA	Unit Price (价格)
	D-25	1/2"	31	
	D-25	3/4"	31	
	D-25 DIN 14306	1"	31	
	D-25	1-1/4"	31	
	C-52	3/4"	66	
	C-52	1"	66	
	C-52	1-1/4"	66	
	C-52	1-1/2"	66	
	C-52 DIN14307	2"	66	
	C-52 DIN 86204	2"	66	
	C-52	2-1/2"	66	
	65	1-1/2"	81	
	65	2"	81	
	65	2-1/2"	81	
	65	3"	81	
	B-75	2"	89	
	B-75 DIN 14308	2-1/2"	89	
	B-75 DIN 86205	2-1/2"	89	
	B-75	3"	89	
	A-110	4"	133	
	A-110 DIN 14309	4-1/2"	133	



STORZ COUPLING WITH FEMALE THREAD

STYLE (型号)	SIZE (尺寸)	KA	Unit Price (价格)
	C/D DIN 14341	66/31	
	65/C	81/66	
	B/65	89/81	
	B/C DIN 14342	89/66	
	A/B DIN 14343	133/89	



STORZ COUPLING STORZ X STORZ REDUCE TYPE

STYLE (型号)	SIZE (尺寸)	Thread	KA	Unit Price (价格)
D-25		1/2"	31	
D-25		3/4"	31	
D-25		1"	31	
D-25		1-1/4"	31	
C-52		3/4"	66	
C-52		1"	66	
C-52		1-1/4"	66	
C-52		1-1/2"	66	
C-52		2"	66	
C-52		2-1/2"	66	
65		1-1/2"	81	
65		2"	81	
65		2-1/2"	81	
65		3"	81	
B-75		2"	89	
B-75 DIN 14308		2-1/2"	89	
B-75 DIN 86205		2-1/2"	89	
B-75		3"	89	
A-110		4"	133	
A-110 DIN 14309		4-1/2"	133	



STORZ COUPLING WITH MALE THREAD

STYLE (型号)	SIZE (尺寸)	KA	Unit Price (价格)
D-25 DIN 14310		31	
C-52 DIN 14311		66	
C-52 DIN 86206		66	
B-75 DIN 14312		89	
B-75 DIN 86207		66	
A-110 DIN14313		133	



STORZ COUPLING WITH CAP

STYLE (型号)	SIZE (尺寸)	PAPT#(料号)	Unit Price (价格)
Storz 2" x 1-1/2" F NST		ST2015SFNST	
Storz 2-1/2" x 1-1/2" F NST		ST2515SFNST	
Storz 3" x 3" F NST		ST3030SFNST	
Storz 4" x 3" F NST		ST4030SFNST	
Storz 4" x 4" F NST		ST4040SFNST	
Storz 4" x 2-1/2" F NST		ST4025SFNST	
Storz 5" x 2-1/2" F NST		ST5025SFNST	
Storz 5" x 4" F NST		ST5040SFNST	
Storz 5" x 4-1/2" F NST		ST5045SFNST	
Storz 5" x 5" F NST		ST5050SFNST	
Storz 5" x 6" F NST		ST5060SFNST	



Storz x Expansion Female

STYLE (型号)	SIZE (尺寸)	PAPT#(料号)	Unit Price (价格)
Storz 4" x 2-1/2" F NST		ST4025FNST	
Storz 5" x 2-1/2" F NST		ST5025FNST	
Storz 5" x 4-1/2" F NST		ST5045FNST	
Storz 5" x 4" F NPT		ST5040FNPT	
Storz 5" x 5" F NPT		ST5050FNPT	
Storz 5" x 6" F NPT		ST5060FNPT	



Storz X Female

STYLE (型号)	SIZE (尺寸)	PAPT#(料号)	Unit Price (价格)
Storz 2-1/2" x 2-1/2" M NST		ST2525MNST	
Storz 4" x 3" M NST		ST4030MNST	
Storz 4" x 4" M NST		ST4040MNST	
Storz 4" x 2-1/2" M NST		ST4025MNST	
Storz 5" x 2-1/2" M NST		ST5025MNST	
Storz 5" x 4-1/2" M NST		ST5045MNST	



Storz X Male

STYLE (型号)	SIZE (尺寸)	PAPT#(料号)	Unit Price (价格)
Storz Cap 1" DIN14310		STC10	
Storz Cap 2" DIN14311		STC20	
Storz Cap 2-1/2"		STC25	
Storz Cap 3" DIN14312		STC30	
Storz Cap 4"		STC40	
Storz Cap 4-1/2" DIN14313		STC45	
Storz Cap 5"		STC50	



STORZ CAP

STYLE (型号)	SIZE (尺寸)	PAPT#(料号)	Unit Price (价格)
1-1/2" NST		03-107P 10	
1-1/2" NPSH		03-107P 20	



PLASTIC RED HOSE PIPE

STYLE (型号)	SIZE (尺寸)	PAPT#(料号)	Dia	Unit Price (价格)
	DSP 40 Hose Shank Dia 35	GHL-150DSP-1	φ 35	€ 35
	DSP 40 Hose Shank Dia 38	GHL-150DSP-2	φ 38	€ 38
	DSP 40 Hose Shank Dia 45	GHL-150DSP-3	φ 45	€ 45
	DSP 65 Hose Shank Dia 65	GHL-250DSP-1	φ 65	€ 65
	DSP 65 Hose Shank Dia 70	GHL-250DSP-2	φ 70	€ 70
	AR DN 100 Hose Shank Dia 110	GHL-400AR	φ 110	€ 110

DSP管尾
DSP COUPLING WITH HOSE SHANK

STYLE (型号)	SIZE (尺寸)	PAPT#(料号)	Dia	Unit Price (价格)
	DSP 40 Male Thread 1-1/2" W Latch	GML-150DSP-150M		
	DSP 40 Male Thread 2" W Latch	GML-150DSP-200M		
	DSP 40 Male Thread 2-1/2" W Latch	GML-150DSP-250M		
	DSP 65 Male Thread 2" W Latch	GML-250DSP-200M		
	DSP 65 Male Thread 2-1/2" W Latch	GML-250DSP-250M		
	DSP 65 Male Thread 3" W Latch	GML-250DSP-300M		
	AR DN100 Male Thread 2-1/2" W Latch	GML-400AR-250M		
	AR DN100 Male Thread 4" W Latch	GML-400AR-400M		

DSP COUPLING WITH LATCH MALE THREAD

STYLE (型号)	SIZE (尺寸)	PAPT#(料号)	Dia	Unit Price (价格)
	DSP 40 Female Thread 1-1/2" W Latch	GML-150DSP-150F		
	DSP 40 Female Thread 2" W Latch	GML-150DSP-200F		
	DSP 65 Female Thread 2" W Latch	GML-250DSP-200F		
	DSP 65 Female Thread 2-1/2" W Latch	GML-250DSP-250F		
	DSP 65 Female Thread 3" W Latch	GML-250DSP-300F		
	AR DN100 Female Thread 2-1/2" W Latch	GML-400AR-250F		
	AR DN100 Female Thread 3" W Latch	GML-400AR-300F		
	AR DN100 Female Thread 4" W Latch	GML-400AR-400F		
	AR DN100 Female Thread 4-1/2" W Latch	GML-400AR-450F		

DSP COUPLING WITH LATCH FEMALE THREAD

STYLE (型号)	SIZE (尺寸)	PAPT#(料号)	Dia	Unit Price (价格)
	DSP 40 Male Thread 1-1/2" W/O Latch	GM-150DSP-150M		
	DSP 40 Male Thread 2" W/O Latch	GM-150DSP-200M		
	DSP 65 Male Thread 2" W/O Latch	GM-250DSP-200M		
	DSP 65 Male Thread 2-1/2" W/O Latch	GM-250DSP-250M		
	AR DN100 Male Thread 2-1/2" W/O Latch	GM-400AR-250M		
	AR DN100 Male Thread 4" W/O Latch	GM-400AR-400M		

DSP COUPLING WITHOUT LATCH MALE THREAD

STYLE (型号)	SIZE (尺寸)	PAPT#(料号)	Dia	Unit Price (价格)
	DSP 40 Female Thread 1-1/2" W/O Latch	GF-150DSP-150F		
	DSP 40 Female Thread 2" W/O Latch	GF-150DSP-200F		
	DSP 40 Female Thread 2-1/2" W/O Latch	GF-150DSP-250F		
	DSP 65 Female Thread 2" W/O Latch	GF-250DSP-200F		
	DSP 65 Female Thread 2-1/2" W/O Latch	GF-250DSP-250F		
	DSP 65 Female Thread 3" W/O Latch	GF-250DSP-300F		
	AR DN100 Female Thread 2-1/2" W/O Latch	GF-400AR-250F		
	AR DN100 Female Thread 3" W/O Latch	GF-400AR-300F		
	AR DN100 Female Thread 4" W/O Latch	GF-400AR-400F		
	AR DN100 Female Thread 4-1/2" W/O Latch	GF-400AR-450F		





DSP COUPLING WITHOUT LATCH FEMALE THREAD

STYLE (型号)	SIZE (尺寸)	PAPT#(料号)	Dia	Unit Price (价格)
	DSP DN 40 TO DSP DN 65	GC1525DSP		
	DSP DN 40 TO AR DN 100	GC1540DSP		
	DSP DN 65 TO AR DN100	GC2540DSP		

DSP COUPLING REDUCED TYPE

STYLE (型号)	SIZE (尺寸)	PAPT#(料号)	Dia	Unit Price (价格)
	CAP DSP 40	GBC-150DSP		
	CAP DSP 65	GBC-250DSP		
	CAP AR DN100	GBC-400AR		

DSP COUPLING CAP

STYLE (型号)	SIZE (尺寸)	PAPT#(料号)	Unit Price (价格)
	16-189-50		
	16-190-50		
	16-233-50		
	16-233-50		
	Cast Iron Painted Red	16-233-50	
		16-190-50	
		16-189-50	
	1-1/2"	SP150	
	2"	SP200	
	2-1/2"	SP250	
	3"	SP300	
	4"	SP400	

UNIVERSAL SPANNER
ADJUSTABLE COMBINATION SPANNER
SPANNER WRENCH ZINC PLATED PIN LUG ONLY

90° 扩口式直通终端接头	代号	螺纹(UNJF-3A)
	482203	3/8"-24 X ANPT1/8"-27
	482204	7/16"-20 X ANPT1/8"-27
	482206	9/16"-18 X ANPT1/4"-18
	482207	3/4"-16 X ANPT1/4"-18
	482208	3/4"-16 X ANPT3/8"-18
	482209	7/8"-14 X ANPT3/4"-14
	482210	7/8"-14 X ANPT1/2"-14
	482211	7/8"-14 X ANPT3/8"-18
	482212	1-1/16"-12 X ANPT3/4"-14
	482244	7/16"-20 X ANPT1/4"-18
	482262	9/16"-18 X ANPT1/8"-27
	482266	9/16"-18 X ANPT3/8"-18
	482268	9/16"-18 X ANPT1/2"-14
	482288	3/4"-16 X ANPT1/2"-14
	482213	1-1/16"-12 X ANPT1/2"-14
	482215	1-5/16"-12 X ANPT3/4"-14
	482216	1-5/16"-12 X ANPT1-1/2"-11

45° 扩口式直通终端接头	代号	螺纹(UNJF-3A)
	482303	3/8"-24 X ANPT1/8"-27
	482304	7/16"-20 X ANPT1/8"-27
	482306	9/16"-18 X ANPT1/4"-18
	482307	3/4"-16 X ANPT1/4"-18
	482308	3/4"-16 X ANPT3/8"-18
	482310	7/8"-14 X ANPT1/2"-14
	482311	7/8"-14 X ANPT3/8"-18
	482312	1-1/16"-12 X ANPT3/4"-14
	482313	1-1/16"-12 X ANPT1/2"-14
	482316	1-5/16"-12 X ANPT1-1/2"-11
	482344	7/16"-20 X ANPT1/4"-18
	482362	9/16"-18 X ANPT1/8"-27
	482366	9/16"-18 X ANPT3/8"-18
	482368	9/16"-18 X ANPT1/2"-14
	482388	3/4"-16 X ANPT1/2"-14

90° 扩口式直通承插接头	代号	螺纹(UNJF-3A)
	498101	3/8"-24
	498102	7/16"-20
	498103	9/16"-18
	498104	3/4"-16
	498105	7/8"-14
	498106	1-1/16"-12
	498108	1-5/16"-12

90° 扩口式直通穿板接头	代号	螺纹(UNJF-3A)
	483303	3/8"-24
	483304	7/16"-20
	483306	9/16"-18
	483308	3/4"-16
	483310	7/8"-14
	483312	1-1/16"-12
	483316	1-5/16"-12

90° 扩口式直通中间接头	代号	螺纹(UNJF-3A)
	482103	2- 3/8"-24
	482104	2- 7/16"-20
	482106	2- 9/16"-18
	482108	2- 3/4"-16
	482110	2- 7/8"-14
	482112	2- 1-1/16"-12
	482116	2- 1-5/16"-12

90° 扩口式直通内螺纹终端接头	代号	螺纹(UNJF-3A)
	495022	3/8"-24 X ANPT1/8"-27
	495023	7/16"-20 X ANPT1/8"-27

45° 扩口式直通承插接头	代号	螺纹(UNJF-3A)
	498001	3/8"-24
	498002	7/16"-20
	498003	9/16"-18
	498004	
	498005	
	498006	
	498008	

45° 扩口式直通穿板接头	代号	螺纹(UNJF-3A)
	483703	3/8"-24
	483704	7/16"-20
	483706	9/16"-18
	483708	3/4"-16
	483710	7/8"-14
	483712	1-1/16"-12
	483716	1-5/16"-12

扩口式三通侧端穿板接头	代号	螺纹(UNJF-3A)
	480403	3/8"-24
	480404	7/16"-20
	480406	9/16"-18

扩口式三通中间承插接头	代号	螺纹(UNJF-3A)
	498201	2- 3/8"-24
	498202	2- 7/16"-20
	498203	2- 9/16"-18
	498204	2- 3/4"-16
	498203-BL	2- 9/16"-18
	498204-BL	2- 3/4"-16
	498205	2- 7/8"-14
	498206	2- 1-1/16"-12
	498208	2- 1-5/16"-12

扩口式螺母	代号	螺纹(UNJF-3A)
	AN818-4D	7/16"-20
	AN818-6D	9/16"-18
	AN818-8D	3/4"-16
	AN818-10D	

扩口式直通终端接头	代号	螺纹(UNJF-3A)
	AN816-4D	UNJF7/16"-20 X ANPT1/8"-27
	AN816-6D	UNJF9/16"-18 X ANPT1/4"-18
	AN816-8D	UNJF3/4"-16 X ANPT3/8"-18

扩口式三通中间穿板接头	代号	螺纹(UNJF-3A)
	483403	3/8"-24
	483404	7/16"-20
	483406	9/16"-18
	483408	3/4"-16
	483410	7/8"-14
	483412	1-1/16"-12
	483416	1-5/16"-12

扩口式三通侧端承插接头	代号	螺纹(UNJF-3A)
	498301	2-3/8"-24
	498302	2-7/16"-20
	498303	2-9/16"-18
	498304	2-3/4"-16
	498305	2-7/8"-14
	498306	2-1/16"-12
	498308	2-1-5/16"-12

扩口式管套	代号	螺纹(UNJF-3A)
	MS20819-4D	管子外径D01/4"
	MS20819-6D	管子外径D03/8"
	MS20819-8D	管子外径D01/2"
	MS20819-10D	管子外径D05/8"

终端螺纹X管接	代号	螺纹(UNJF-3A)
	AN840-4D	NPT1/8"-27
	AN840-6D	NPT1/4"-18
	AN840-8D	NPT3/8"-18

扩口式三通中间接头	代号	螺纹(UNJF-3A)
	482403	3/8"-24
	482404	7/16"-20
	482406	9/16"-18
	482408	3/4"-16
	482410	7/8"-14
	482412	1-1/16"-12
	482416	1-5/16"-12

扩口式三通侧端穿板接头	代号	螺纹(UNJF-3A)
	580403	3/8"-24
	580404	7/16"-20
	580406	9/16"-18

扩口式直通中间接头	代号	螺纹(UNJF-3A)
	AN815-4D	7/16"-20
	AN815-6D	9/16"-18
	AN815-8D	3/4"-16

扩口式直通穿板接头	代号	螺纹(UNJF-3A)
	AN832-4D	UNJF7/16"-20
	AN832-6D	UNJF9/16"-18
	AN832-8D	UNJF3/4"-16

45° 弯通承插式接头



代号	螺纹
496203	
496204	
496206	
496208	
496210	
496212	
496216	

45° 弯通快插式接头



代号	螺纹
204606	
204608	
204610	
204612	
204616	

90° 弯通承插式接头



代号	螺纹
496303	
496304	
496306	
496308	
496310	
496312	
496316	

90° 弯通快插式接头



代号	螺纹
209106	
209108	
209110	
209112	
209116	

扩口式三通侧端终端接头



代号	螺纹(UNJF-3A)
482603	2-3/8"-24 X ANPT1/8"-27
482604	2-7/16"-20 X ANPT1/8"-27
482606	2-9/16"-18 X ANPT1/4"-18
482608	2-3/4"-16 X ANPT3/8"-18
482610	2-7/8"-14 X ANPT1/2"-14

90° 扩口式弯通快插接头



代号	螺纹
400803	
400804	
400806	
400808	
400810	
400812	

45° 弯通异径快接



代号	螺纹
104606	
104608	
104610	
104612	
104616	

90° 弯通异径快接



代号	螺纹
109103	
109104	
109106	
109108	
109110	
109112	
109116	

CARBON STEEL ZINC PLATING



UNIVERSAL COUPLING HOSE END

STYLE (型号)	SIZE (尺寸)	PAPT#(料号)	Unit Price (价格)
	1/4"	UCHE025	
	3/8"	UCHE040	
	1/2"	UCHE050	
	3/4"	UCHE075	
	1"	UCHE100	
	1-1/4"	UCHE125	
	1-1/2"	UCHE150	
	2"	UCHE200	

STYLE (型号)



UNIVERSAL COUPLING HOSE END

STYLE (型号)	SIZE (尺寸)	PAPT#(料号)	Unit Price (价格)
	1/4"	UCHE025-1	
	3/8"	UCHE040-1	
	1/2"	UCHE050-1	
	3/4"	UCHE075-1	
	1"	UCHE100-1	
	1-1/4"	UCHE125-1	
	1-1/2"	UCHE150-1	
	2"	UCHE200-1	

STYLE (型号)



UNIVERSAL COUPLING MALE END

STYLE (型号)	SIZE (尺寸)	PAPT#(料号)	Unit Price (价格)
	1/4"	UCME025	
	3/8"	UCME040	
	1/2"	UCME050	
	3/4"	UCME075	
	1"	UCME100	

STYLE (型号)



UNIVERSAL COUPLING FEMALE END

STYLE (型号)	SIZE (尺寸)	PAPT#(料号)	Unit Price (价格)
	1/4"	UCFE025	
	3/8"	UCFE040	
	1/2"	UCFE050	
	3/4"	UCFE075	
	1"	UCFE100	
	1-1/4"	UCFE125	
	1-1/2"	UCFE150	
	2"	UCFE200	

MALLEABLE IRON-ZNPLATED

STYLE (型号)	SIZE (尺寸)	PAPT#(料号)	Unit Price (价格)
	1/4"	UCHE025-EC	
	3/8"	UCHE040-EC	
	1/2"	UCHE050-EC	
	3/4"	UCHE075-EC	
	1"	UCHE100-EC	
	1-1/4"	UCHE125-EC	
	1-1/2"	UCHE150-EC	
	2"	UCHE200-EC	

UNIVERSAL COUPLING EURO HOSE END COLLAR

STYLE (型号)	SIZE (尺寸)	PAPT#(料号)	Unit Price (价格)
	1/4"	UCHE025-E	
	3/8"	UCHE040-E	
	1/2"	UCHE050-E	
	3/4"	UCHE075-E	
	1"	UCHE100-E	
	1-1/4"	UCHE125-E	
	1-1/2"	UCHE150-E	
	2"	UCHE200-E	

UNIVERSAL COUPLING EURO HOSE END

STYLE (型号)	SIZE (尺寸)	PAPT#(料号)	Unit Price (价格)
	1/4"	UCME025-E	
	3/8"	UCME040-E	
	1/2"	UCME050-E	
	3/4"	UCME075-E	
	1"	UCME100-E	

UNIVERSAL COUPLING EURO MALE END

STYLE (型号)	SIZE (尺寸)	PAPT#(料号)	Unit Price (价格)
	1/4"	UCFE025-E	
	3/8"	UCFE040-E	
	1/2"	UCFE050-E	
	3/4"	UCFE075-E	
	1"	UCFE100-E	
	1-1/4"	UCFE125-E	
	1-1/2"	UCFE150-E	
	2"	UCFE200-E	

UNIVERSAL COUPLING EURO FEMALE END

STYLE (型号)	SIZE (尺寸)	PAPT#(料号)	Unit Price (价格)
	1-1/4"	SCFE125AL	
	1-1/2"	SCFE150AL	
	1-1/4"	SCFE125BR	
	1-1/2"	SCFE150BR	

SANDBLAST COUPLING FEMALE END

STYLE (型号)	SIZE (尺寸)	PAPT#(料号)	Unit Price (价格)
	1/2"	SCHE050AL	
	3/4"	SCHE075AL	
	1"	SCHE100AL	
	1-1/4"	SCHE125AL	
	1-1/2"	SCHE150AL	
	Q6	SCHEQ6AL	
	Q2X	SCHEQ2XAL	
	Q3X	SCHEQ3XAL	
	Q4X	SCHEQ4XAL	
	Q6X	SCHEQ6XAL	
	3/4"	SCHE075BR	
	1"	SCHE100BR	
	1-1/4"	SCHE125BR	
1-1/2"	SCHE150BR		

SANDBLAST COUPLING HOSE END

STYLE (型号)	SIZE (尺寸)	PAPT#(料号)	Unit Price (价格)
	3/4"	SCNH075AL	
	1"	SCNH100AL	
	1-1/4"	SCNH125AL	
	1-1/2"	SCNH150AL	
	3/4"	SCNH075BR	
	1"	SCNH100BR	
	1-1/4"	SCNH125BR	
1-1/2"	SCNH150BR		

SANDBLAST COUPLING NOZZLE HOLDER

STYLE (型号)	PAPT#(料号)	Unit Price (价格)	STYLE (型号)	PAPT#(料号)	Unit Price (价格)
	UCTW			UCBE	

TRI-WAY

BLANK CAP

STYLE (型号)	SIZE (尺寸)	PAPT#(料号)	Unit Price (价格)
	1/2"	GJMS050	
	3/4"	GJMS075	
	1"	GJMS100	
	1-1/4"	GJMS125	
	1-1/2"	GJMS150	
	2"	GJMS200	

GROUND JOINT MALE STEM

STYLE (型号)	SIZE (尺寸)	PAPT#(料号)	Unit Price (价格)
	3/4"	GJMSE075	
	1"	GJMSE100	
	1-1/4"	GJMSE125	
	1-1/2"	GJMSE150	
	2"	GJMSE200	

GROUND JOINT MALE SPUD END

STYLE (型号)	SIZE (尺寸)	PAPT#(料号)	Unit Price (价格)
	3/4"	GJDS075	
	1"	GJDS100	
	1-1/4"	GJDS125	
	1-1/2"	GJDS150	
	2"	GJDS200	

GROUND JOINT DOUBLE SPUD

STYLE (型号)	SIZE (尺寸)	PAPT#(料号)	Unit Price (价格)
	1/2"	GJFS050	
	3/4"	GJFS075	
	1"	GJFS100	
	1-1/4"	GJFS125	
	1-1/2"	GJFS150	
	2"	GJFS200	
	2-1/2"	GJFS250	
	3"	GJFS300	
4"	GJFS400		

GROUND JOINT

STYLE (型号)	SIZE (尺寸)	PAPT#(料号)	Unit Price (价格)
	2"	BTC200	
	3"	BTC300	
	3-1/2"	BTC350	
	4"	BTC400	
	6"	BTC800	
	8"	BTC800	

BAUER TYPE COUPLING

STYLE (型号)	SIZE (尺寸)	PAPT#(料号)	Unit Price (价格)
	2"	BTC200-1	
	3"	BTC300-1	
	3-1/2"	BTC350-1	
	4"	BTC400-1	
	6"	BTC600-1	
8"	BTC800-1		

MALE X HOSE TAIL

STYLE (型号)	SIZE (尺寸)	PAPT#(料号)	Unit Price (价格)
	2"	BTC200-2	
	3"	BTC300-2	
	3-1/2"	BTC350-2	
	4"	BTC400-2	
	6"	BTC600-2	
	8"	BTC800-2	

FEMALE X HOSE TAIL

STYLE (型号)	SIZE (尺寸)	PAPT#(料号)	Unit Price (价格)
	2"	BTC200-3	
	3"	BTC300-3	
	3-1/2"	BTC350-3	
	4"	BTC400-3	
	6"	BTC600-3	
	8"	BTC800-3	

LEVER RING

STYLE (型号)	SIZE (尺寸)	MATERIAL	PAPT#(料号)	Unit Price (价格)
	2"	NBR	BTC200-4	
	3"	NBR	BTC300-4	
	3-1/2"	NBR	BTC350-4	
	4"	NBR	BTC400-4	
	6"	NBR	BTC600-4	
	8"	NBR	BTC800-4	

LEVER GASKET

STYLE (型号)	SIZE (尺寸)	PAPT#(料号)	Unit Price(价格)
	2"	BTC200-M	
	3"	BTC300-M	
	3-1/2"	BTC350-M	
	4"	BTC400-M	
	6"	BTC800-M	
	8"	BTC800-M	

BAUER TYPE COUPLING WITH MALE THREAD

STYLE (型号)	SIZE (尺寸)	PAPT#(料号)	Unit Price(价格)
	2"	BTC200-FL	
	3"	BTC300-FL	
	4"	BTC400-FL	
	6"	BTC800-FL	
	8"	BTC800-FL	

BAUER TYPE COUPLING WITH FLANGE

STYLE (型号)	SIZE (尺寸)	PAPT#(料号)	Unit Price(价格)
	2"	BTC200-KC	
	3"	BTC300-KC	
	3-1/2"	BTC350-KC	
	4"	BTC400-KC	
	6"	BTC800-KC	
	8"	BTC800-KC	

BAUER TYPE COUPLING WITH KING NIPPLES

STYLE (型号)	SIZE (尺寸)	PAPT#(料号)	Unit Price(价格)
	2"	BTC200-ST	
	3"	BTC300-ST	
	4"	BTC400-ST	
	6"	BTC800-ST	
	8"	BTC800-ST	

BAUER TYPE COUPLING WITH STRAINER

STYLE	SIZE	PAPT#	Unit Price	SIZE	PAPT#	Unit Price
	1/2"	KC050		1/2"	KC050-SS	
	3/4"	KC075		3/4"	KC075-SS	
	1"	KC100		1"	KC100-SS	
	1-1/4"	KC125		1-1/4"	KC125-SS	
	1-1/2"	KC150		1-1/2"	KC150-SS	
	2"	KC200		2"	KC200-SS	
	2-1/2"	KC250		2-1/2"	KC250-SS	
	3"	KC300		3"	KC300-SS	
	4"	KC400		4"	KC400-SS	
	5"	KC500		2"	KC200-PP	
	6"	KC600		2-1/2"	KC250-PP	
	8"	KC800		3"	KC300-PP	
10"	KC1000		4"	KC400-PP		
12"	KC1200					

COMBINATION NIPPLES

STYLE	SIZE	PAPT#	Unit Price	SIZE	PAPT#	Unit Price
	1/2"	HM050		1/2"	HM050-SS	
	3/4"	HM075		3/4"	HM075-SS	
	1"	HM100		1"	HM100-SS	
	1-1/4"	HM125		1-1/4"	HM125-SS	
	1-1/2"	HM150		1-1/2"	HM150-SS	
	2"	HM200		2"	HM200-SS	
	2-1/2"	HM250		2-1/2"	HM250-SS	
	3"	HM300		3"	HM300-SS	
	4"	HM400		4"	HM400-SS	
	5"	HM500				
	6"	HM600				
	8"	HM800				
10"	HM1000					
12"	HM1200					

HOSE MENDER

STYLE	SIZE	Clamp Range	PAPT#	Unit Price
	SL22 (3/8")	21/32"-7/8"	SL22	
	SL29 (1/2")	7/8"-1-9/64"	SL29	
	SL34 (3/4")	1-5/32"-1-11/32"	SL34	
	SL40 (1")	1-5/16"-1-19/32"	SL40	
	SL49 (1-1/4")	1-5/8"-1-15/16"	SL49	
	SL60 (1-1/2")	1-7/8"-2-3/8"	SL60	
	SL76 (2")	2-3/8"-3-7/16"	SL76	
	SL94 (2-1/2")	3-1/2"-3-11/16"	SL94	
	SL115 (3")	3-3/4"-4-1/2"	SL115	
	SL400 (3")	3-1/2"-4"	SL400	
	SL463 (3-1/2")	4-1/16"-4-5/8"	SL463	
	SL525 (3-1/2")	4-11/16"-5-1/4"	SL525	
	SL550 (4")	5"-5-1/2"	SL550	
	SL600 (4")	5-5/16"-6-1/8"	SL600	
	SL675 (5")	6-1/8"-6-7/8"	SL675	
SL769 (6")	6-15/16"-7-5/8"	SL769		
SL818 (7")	7-11/16"-8-3/16"	SL818		
SL875 (7")	8-1/4"-8-7/8"	SL875		
SL988 (8")	8-15/16"-9-7/8"	SL988		
SL1125 (10")	9-15/16"-11-3/8"	SL1125		
SL1275 (12")	11-3/16"-13"	SL1275		

DOUBLE BOLT CLAMP

STYLE	SIZE	Clamp Range	Left Hand	Right Hand	Unit Price
	1"		SHC100L	SHC100R	
	1.2"		SHC120L	SHC120R	
	1.5"	(38mm-43mm)	SHC150L	SHC150R	
	2"	(51mm-56mm)	SHC200L	SHC200R	
	2.2"		SHC220L	SHC220R	
	2.5"	(64mm-75mm)	SHC250L	SHC250R	
	3"	(76mm-89mm)	SHC300L	SHC300R	
	3.5"		SHC350L	SHC350R	
	4"	(102mm-120mm)	SHC400L	SHC400R	
	4.5"		SHC450L	SHC450R	
	5"	(127mm-140mm)	SHC500L	SHC500R	
	5.5"		SHC550L	SHC550R	
	6"	(152mm-172mm)	SHC600L	SHC600R	
6.5"		SHC650L	SHC650R		
8"	(203mm-215mm)	SHC800L	SHC800R		
8.5"		SHC850L	SHC850R		
10"	(254mm-285mm)	SHC1000L	SHC1000R		
12"	(305mm-333mm)	SHC1200L	SHC1200R		

SPIRAL HOSE CLAMP

STYLE	SIZE	PAPT#	Unit Price
	1/2"	IC050	
	3/4"	IC075	
	1"	IC100	
	1-1/4"	IC125	
	1-1/2"	IC150	
	2"	IC200	

INTERLOK CLAMP

STYLE	SIZE	PAPT#	Unit Price
	1-1/2"	STZC-150	
	2-1/2"	STZC-250	
	4"	STZC-400	
	5"	STZC-500	
	6"	STZC-600	

INTERLOK CLAMP

STYLE	SIZE	PAPT#	Unit Price
	1"	FC-100-SS	
	1-1/4"	FC-125-SS	
	1-1/2"	FC-150-SS	
	2"	FC-200-SS	
	2-1/2"	FC-250-SS	
	3"	FC-300-SS	
	4"	FC-400-SS	

CRIMPING FERRULES IN STAINLESS STEEL

STYLE	SIZE	PAPT#	Unit Price
	1-1/2"	FC-150-AL	
	2"	FC-200-AL	
	2-1/2"	FC-250-AL	
	3"	FC-300-AL	
	4"	FC-400-AL	

CRIMPING FERRULES IN ALUMIUM

STYLE (型号)	SIZE (尺寸)	PAPT# (料号)	Unit Price (价格)
	1"	BST100	
	1-1/2"	BST150	
	2"	BST200	
	2-1/2"	BST250	
	3"	BST300	
	4"	BST400	
	6"	BST600	
	8"	BST800	

TIN STRAINER

STYLE (型号)	SIZE (尺寸)	PAPT# (料号)	Unit Price (价格)
	1"	BS100	
	1-1/2"	BS150	
	2"	BS200	
	2-1/2"	BS250	
	3"	BS300	
	4"	BS400	
	6"	BS600	
	8"	BS800	

STRAINER

STYLE (型号)	SIZE (尺寸)	PAPT# (料号)	Unit Price (价格)
	1-1/2"	FV150	
	2"	FV200	
	2-1/2"	FV250	
	3"	FV300	
	4"	FV400	
	6"	FV600	
	8"	FV800	

FOOT VALVE

STYLE (型号)	Safety Cable Hose to Hose		Unit Price
	SIZE	PAPT#	
	1/8**20-1/4"	SCHTH20	
	1/4**38	SCHTH38	
	Safety Cable Hose to Tool		Unit Price
	SIZE	PAPT#	
	1/8**20-1/4"	SCHTT20	
	1/4**38	SCHTT38	

SAFETY CABLE



浙江伟鑫金属制品有限公司
ZHEJIANG WAYSING METAL PRODUCTS CO.,LTD.

Memo

品质成就卓越

Quality Accomplishing Eminence

